



WELD THE WORLD

Discovery 3200T Discovery 4000T Discovery 5000T

Instruction Manual

ENGLISH

Translation of original instructions

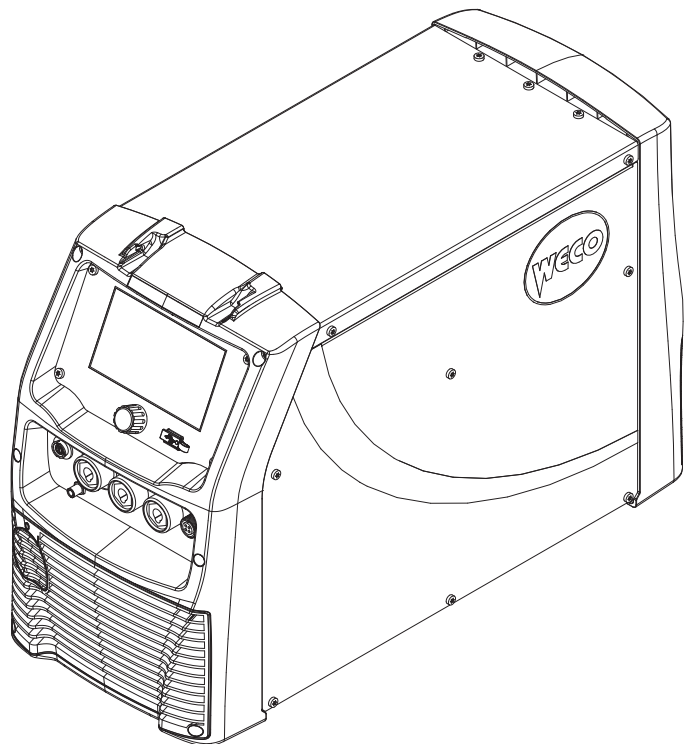



INDEX

1	GENERAL INFORMATION	6
1.1	PRESENTATION	7
1.2	CONNECTIONS AND SOCKETS	8
1.3	PREPARING FOR TIG WELDING	10
1.4	PREPARING FOR MMA WELDING	12
1.5	PREPARATION FOR AIR CARBON ARC (ACA) GOUGING	13
2	USER INTERFACE	15
2.1	MAIN SCREEN	16
2.2	WELDING PARAMETERS SETTING	17
2.3	SPECIAL FUNCTION PARAMETERS SETTING	20
2.4	SIMPLIFIED INTERFACE	21
3	PRELIMINARY SETTINGS	22
3.1	LANGUAGE SETTING	22
3.2	FIRMWARE UPGRADE	23
3.3	DATE AND TIME SETTING	25
3.4	SYSTEM SETTINGS	29
3.4.1	HF Setup	30
3.4.2	Torch setup	33
3.4.3	Cooling unit setup	34
3.4.4	Display setup	35
3.4.5	Gas setup	37
3.4.6	Remote control setup	39
3.5	IMPORT/EXPORT SETTINGS	41
3.5.1	Export	42
3.5.2	Import	42
3.5.3	Adding jobs	43
3.6	SETTING GUARD LIMITS	44
3.6.1	Guard limits activation	44
3.6.2	Guard limits reset	46
4	TIG DC WELDING	47
4.1	TIG DC PROCESS SELECTION	47
4.2	PROCESS PARAMETERS SETTING	48
4.2.1	Torch trigger	49
4.2.2	Spot / pause	52
4.2.3	Parameter mode	53
4.3	TORCH TRIGGER MODE SETTING	54
4.3.1	2 strokes mode with lift ignition	55
4.3.2	2 strokes mode with HF ignition	55
4.3.3	4 strokes mode with lift ignition	56
4.3.4	4 strokes mode with HF ignition	57
4.3.5	4 strokes B-Level mode with lift ignition	58
4.3.6	4 strokes B-Level mode with HF ignition	59
4.4	WELDING SETTINGS	60
4.4.1	Pulsed	61



ENGLISH

4.4.2	Multiple Pulse (MPULSE)	64
4.4.3	Q-SPOT	66
4.4.4	Q-Start	67
4.4.5	Dynamic arc	68
4.4.6	Electrode diameter	70
5	MMA WELDING	71
5.1	MMA PROCESS SELECTION	71
5.2	PROCESS PARAMETERS SETTING	72
5.2.1	MMA parameters (parameters menu)	73
5.2.2	MMA parameters (main screen)	75
6	ARC AIR GOUGING	77
6.1	ARC AIR PROCESS SELECTION	77
6.1.1	ARC AIR parameters (main screen)	78
7	FAVORITES KEY SETTING	79
8	JOBS MANAGEMENT	81
8.1	CREATE A JOB	81
8.2	OVERWRITE A JOB	83
8.3	LOAD A JOB	84
8.4	DELETING A JOB	84
8.5	EXPORT JOBS	85
8.6	IMPORT JOBS	86
8.7	ADD JOBS	87
8.8	JOB ADJUSTMENT FREQUENCY	88
9	USER MANAGEMENT	90
9.1	AUTHORISATION LEVELS	91
9.2	ASSOCIATING AN NFC KEY	92
9.3	USING AN NFC KEY	93
9.4	DELETING AN NFC KEY	94
9.5	CREATING A NEW USER	95
9.5.1	Copying a user	96
9.6	REMOVING A USER	97
9.7	RESET USER	98
9.8	MANAGING USER PERMISSIONS	99
10	RESET	102
10.1	RESET PARAMS	102
10.2	RESET PARAMS AND JOBS	103
10.3	RESET DISPLAY SETTINGS	105
10.4	FACTORY RESET	106
11	ALARMS MANAGEMENT	108
11.1	ALARMS LIST	109
12	SYSTEM INFO	116

13	WELD LOG	119
13.1	WELD LOG DISPLAY	119
13.2	WELD LOG EXPORT.....	120
14	SERVICE	122
15	VALIDATION	124
16	TECHNICAL DATA.....	126
16.1	DISCOVERY 3200T.....	127
16.2	DISCOVERY 4000T.....	128
16.3	DISCOVERY 5000T.....	129
16.4	DIMENSIONED DRAWINGS.....	130

ENGLISH

1 GENERAL INFORMATION



IMPORTANT! For your safety

This documentation must be consigned to the user prior to installation and commissioning of the unit.

 **Read the manual "GENERAL INSTRUCTIONS FOR USE" provided separately from this manual before installing and commissioning the equipment.**

The meaning of the symbols in this manual and the associated precautionary information are given in the "GENERAL INSTRUCTIONS FOR USE".

If the "GENERAL INSTRUCTIONS FOR USE" are not present, it is mandatory to request a replacement copy from the Manufacturer or from your dealer.

Retain this documentation for future consultation.

Meaning of the symbols



DANGER!

This pictogram warns of danger of death or serious injury.



WARNING!

This pictogram warns of a risk of injury or damage to property.



CAUTION!

This pictogram warns of a potentially hazardous situation.



NOTICE!

This pictogram gives important information concerning the execution of the relevant operations.



Information

This pictogram indicates additional information or refers to another section of the manual with the related information.

○ in the illustrations:



press



turn the encoder



press the encoder

○ **Note:** The images contained in this manual are for illustrative purposes only: the setup present in the final product may be different.

1.1 PRESENTATION

Discovery 3200T - 4000T - 5000T are advanced three-phase current sources designed for TIG DC welding. They also support MMA welding and ARC AIR gouging.

These electronic devices are managed by high-performance digital control systems, suitable for professional-quality welding.

In TIG DC mode, common steels, stainless steels and copper can be easily welded.

TIG DC welding is optimised through a range of user-selectable functions, including: pulsed mode, multi-pulsed mode, Q-Spot, Q-Start, etc.

In MMA mode, electrodes up to 4 mm in diameter can be easily welded.

The Arc Air function is used to remove old, worn or defective welds by cutting with a carbon/graphite electrode.

The generator is cooled by a fan controlled by dedicated thermal sensors.

The fan is turned on only during welding; after welding, it remains on for a predetermined time, depending on the welding conditions, until the machine has cooled down sufficiently.

ENGLISH

1.2 CONNECTIONS AND SOCKETS

Front panel

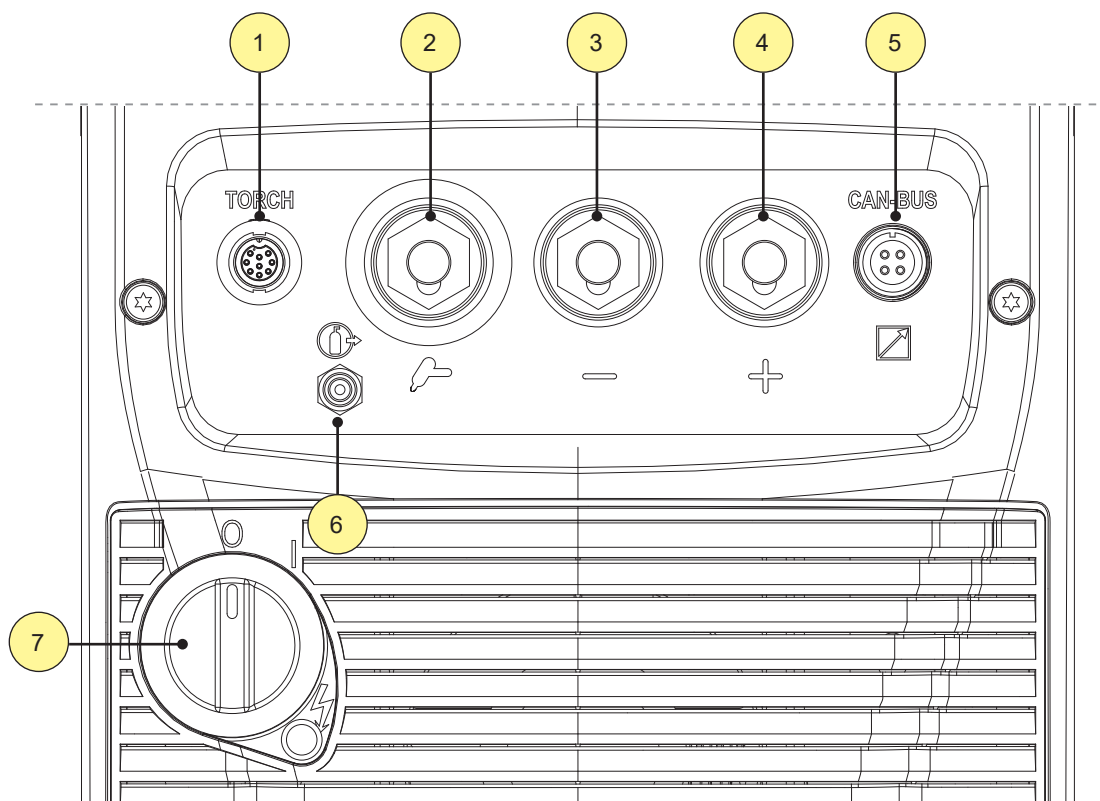

1. TIG torch control connector
2. Welding socket for TIG torch
3. Negative polarity welding socket
4. Positive polarity welding socket
5. Connector for CAN-BUS devices.
Devices communicating via CAN-BUS (Remote Control, Data Manager, IR robot interface, etc. can be connected to this connector).
6. Gas supply hose connector.
Gas flow from the generator to the torch.
7. Switch to turn the generator on and off.

Rear panel

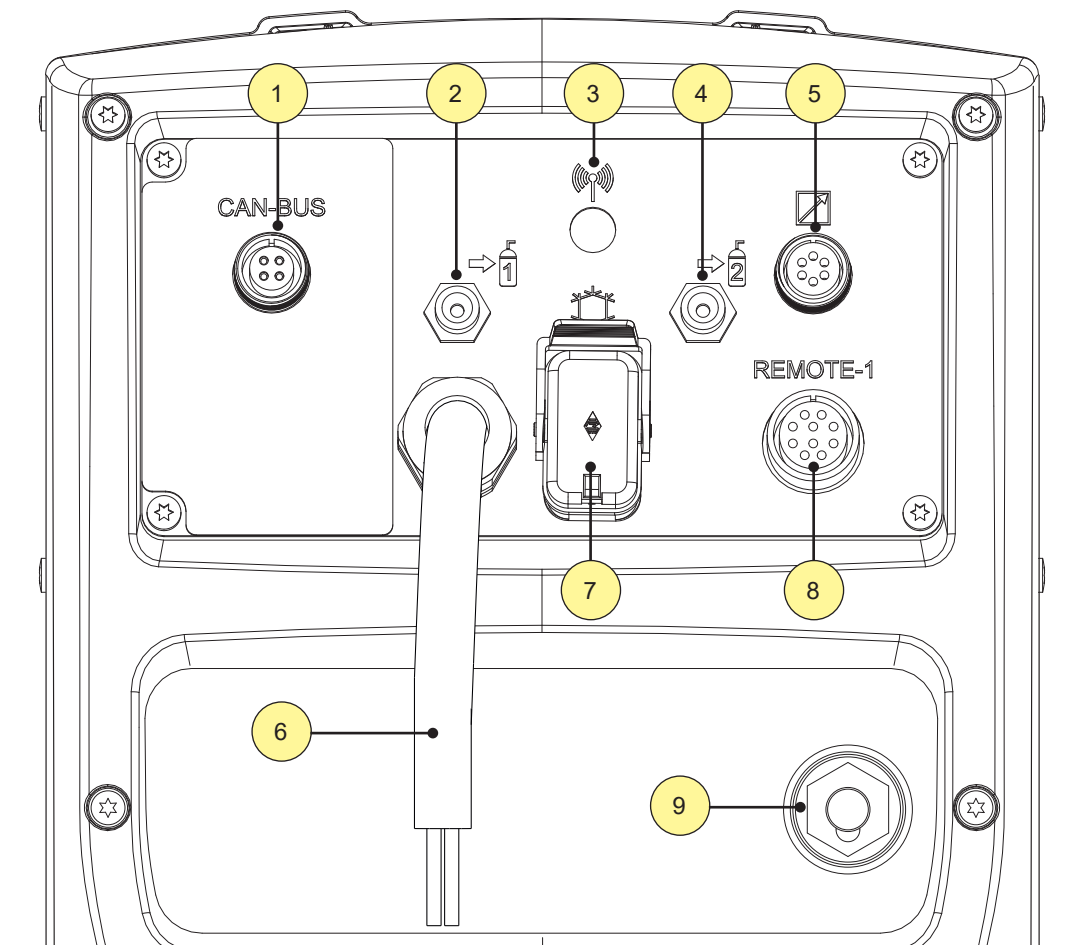

1. Connector for CAN-BUS devices.
Devices communicating via CAN-BUS (Remote Control, Data Manager, IR robot interface, etc. can be connected to this connector).
 2. Primary connector for the gas supply hose.
Gas flow from the cylinder to the generator.
 3. Wi-Fi antenna connector [OPTIONAL].
 4. Secondary connector for the gas supply hose [OPTIONAL].
Gas flow from the cylinder to the generator.
 5. Remote control connector
 6. Power supply cable.
 - Length: 4.5 m
 - Number and section of conductors: 4 x 2.5 mm² (Discovery 3200T), 4 x 4.0 mm² (Discovery 4000T - 5000T)
 - Type of electrical plug: not fitted
 7. Connector for powering the cooling unit.
 - Voltage: 400 Va.c.
 - Current Dispensed: 0.8A
 - IP protection class: IP20 (cap open) / IP66 (cap closed)
- ⚠ DANGER! Dangerous voltage!** If no equipment is connected to the socket, always keep the cover closed.
8. Connector to connect the generator to the remote unit.
 9. Socket to connect the power cable between the generator and the remote device.

ENGLISH

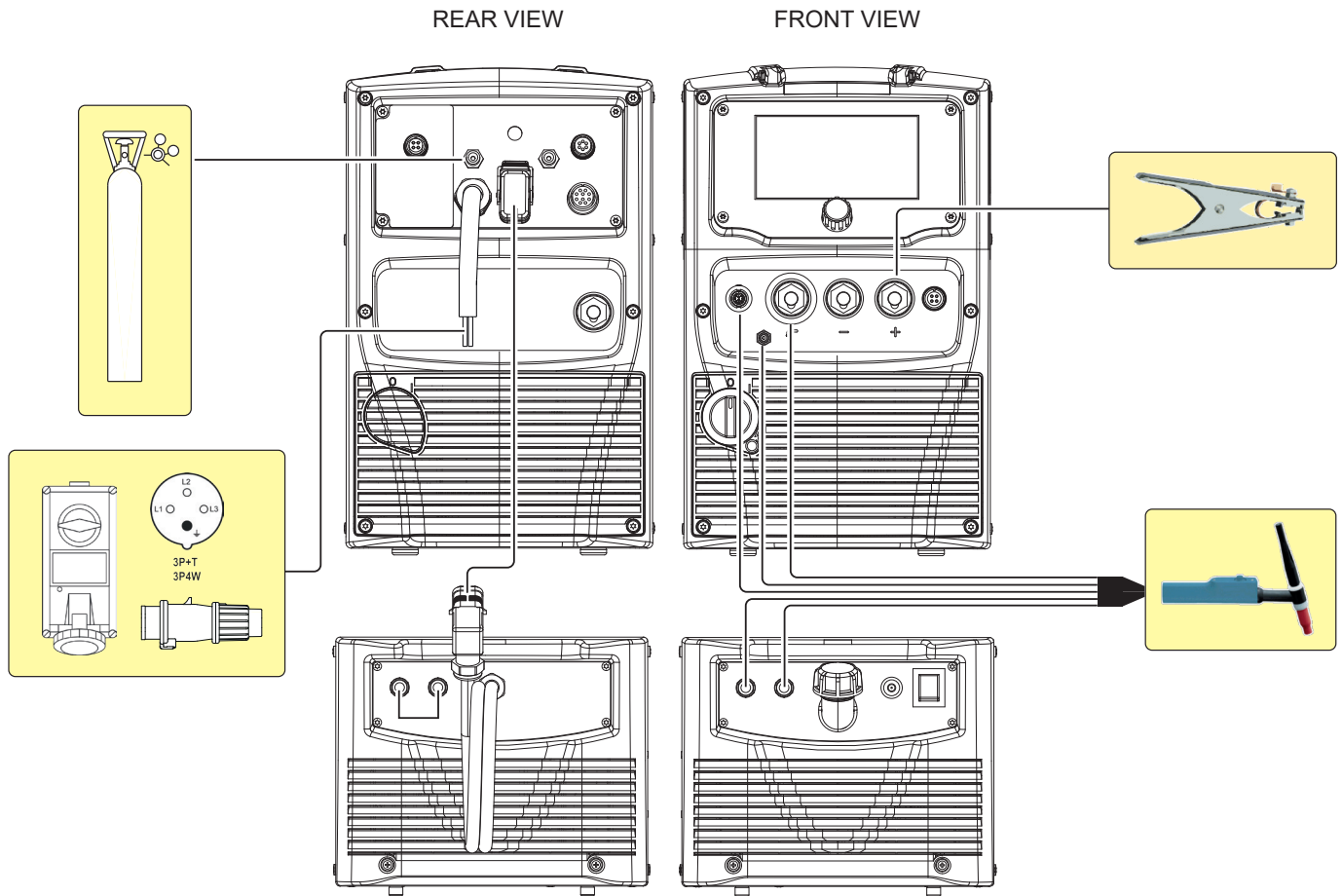

1.3 PREPARING FOR TIG WELDING



Operating procedure

1. Assemble the various units as described in the instruction manual of the generator trolley.

 **NOTICE!** For the assembly procedure between the cooling unit and the generator, refer to the cooling unit instruction manual.

2. Set the current generator ON/OFF switch to "O" (unit switched off).
3. Connect the current generator mains supply cable to the mains socket outlet.
4. Connect the electrical power supply cable of the cooling unit to the auxiliary power socket on the current generator.
5. Connect the TIG torch coolant supply and return hoses (for water-cooled torch models) to the connections on the cooling unit (front panel).
6. Connect the coolant bypass hose to the connections on the cooling unit (rear panel).
7. Connect the gas hose from the welding gas cylinder to the rear gas socket.
8. Open the cylinder gas valve.
9. Choose the electrode based on the type of material and thickness of the workpiece to be welded.
10. Insert the electrode in the TIG torch.
11. Connect the torch plug to the welding socket marked with the symbol .
12. Connect the ground clamp plug to the welding socket marked with the symbol .
13. Connect the welding torch gas hose to the front gas connector .
14. Connect the welding torch connector to the TIG torch logic signal connector.
15. Connect the ground clamp to the workpiece.



DANGER!

Electric shock hazard!

Read the warnings highlighted by the following symbols in the “General instructions for use”.



16. Set the current generator ON/OFF switch to “I” (unit powered).

The system is ready to start welding.

ENGLISH

1.4 PREPARING FOR MMA WELDING

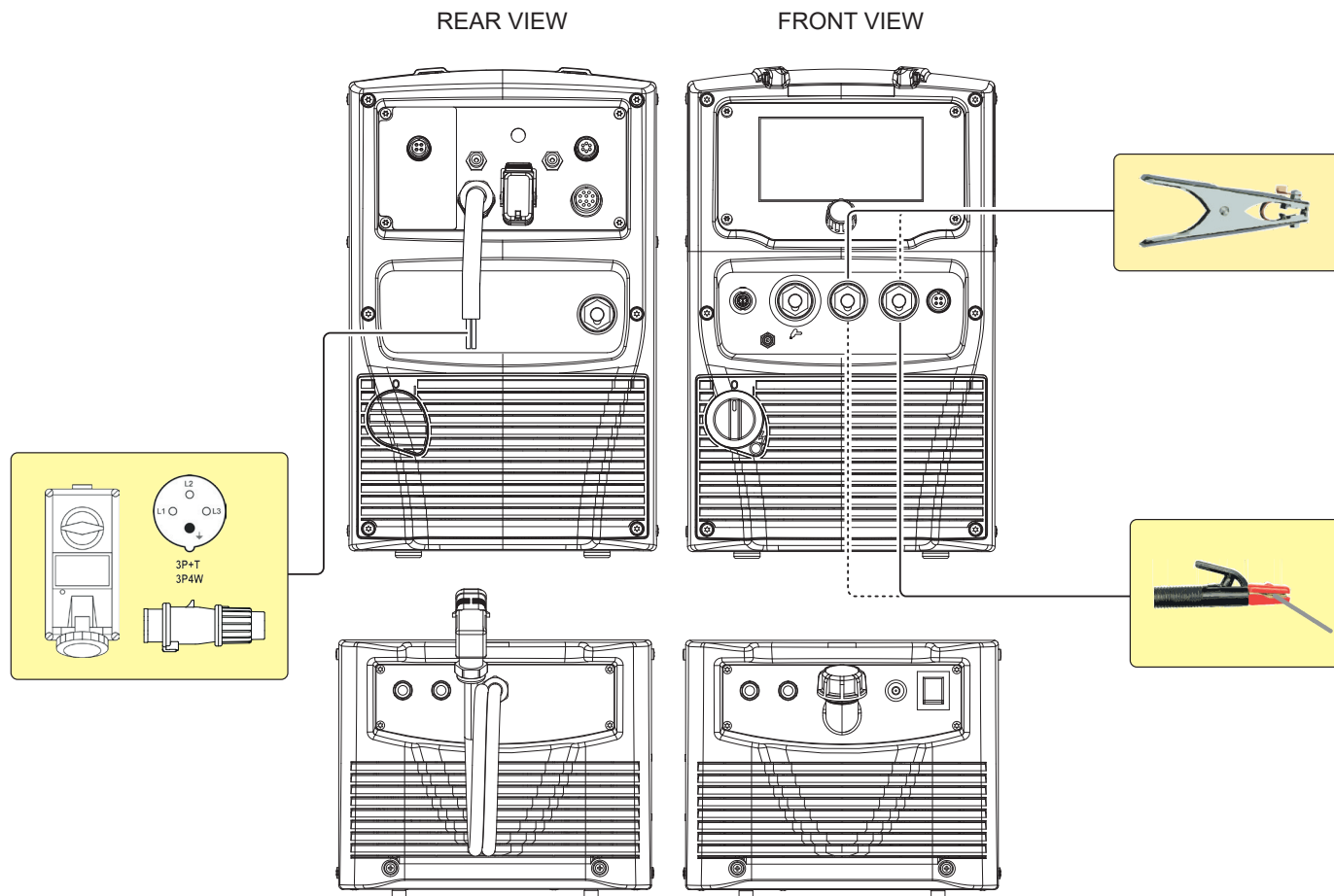

Operating procedure

1. Assemble the various units as described in the instruction manual of the generator trolley.
 **NOTICE!** For the assembly procedure between the cooling unit and the generator, refer to the cooling unit instruction manual.
2. Set the current generator ON/OFF switch to "O" (unit switched off).
3. Plug the power cable plug into a mains socket outlet.
4. Choose the electrode based on the type of material and thickness of the workpiece to be welded.
5. Insert the electrode in the electrode holder.
6. Connect the electrode holder cable to the welding socket based on the polarity requested by the type of electrode used.
7. Connect the plug of the ground clamp to the welding socket on the basis of the polarity required.
8. Connect the ground terminal to the workpiece being processed.



DANGER!

Electric shock hazard!

Read the warnings highlighted by the following symbols in the "General instructions for use".



- Set the current generator ON/OFF switch to "I" (unit powered).

The system is ready to start welding.

1.5 PREPARATION FOR AIR CARBON ARC (ACA) GOUGING

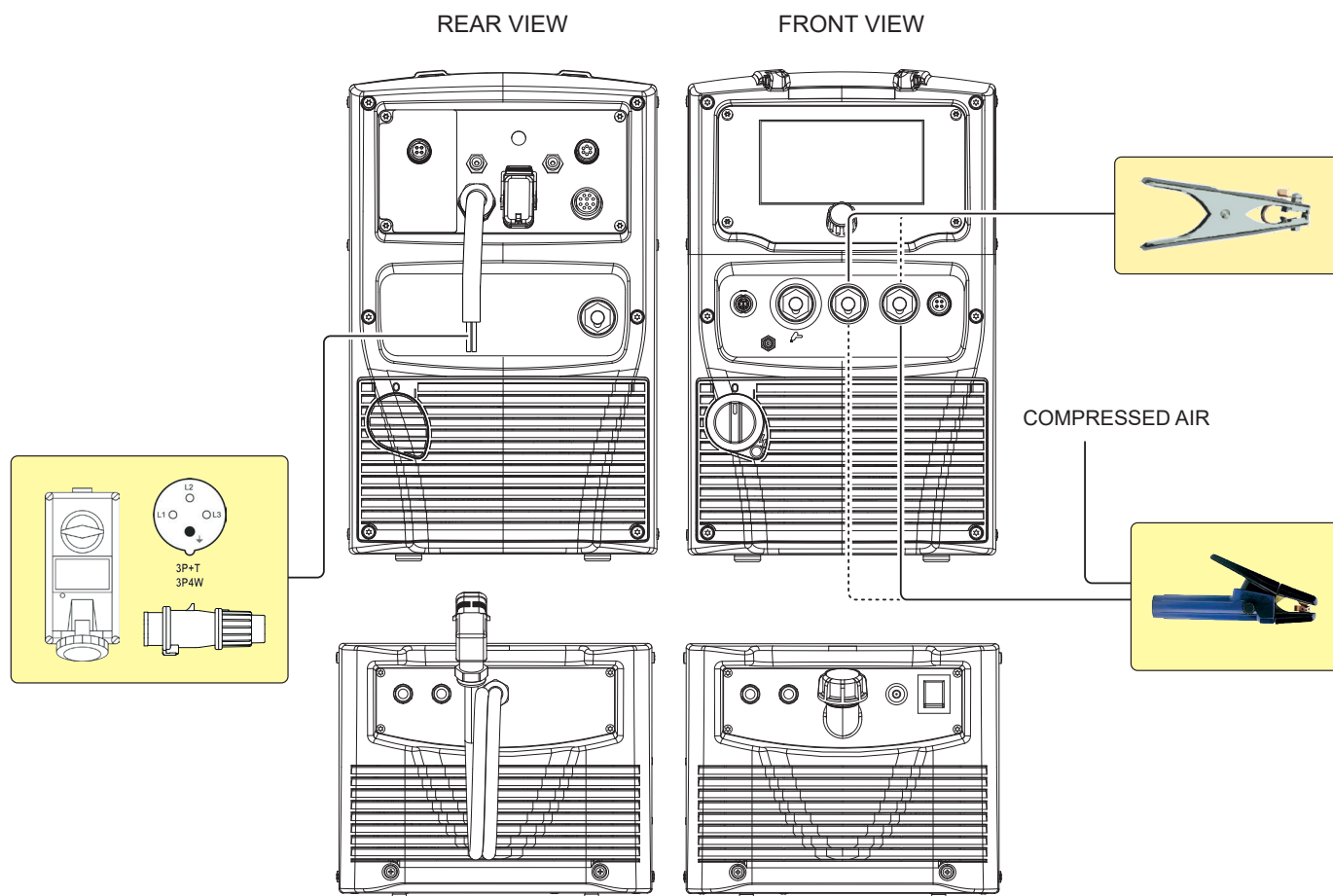

Operating procedure

- Assemble the various units as described in the instruction manual of the generator trolley.
 **NOTICE!** For the assembly procedure between the cooling unit and the generator, refer to the cooling unit instruction manual.
- Set the current generator ON/OFF switch to "O" (unit switched off).
- Plug the power cable plug into a mains socket outlet.
- Choose the electrode based on the type of material and on the thickness of the metal to be removed.
- Insert the electrode in the electrode holder.
- Connect the electrode holder cable to the welding socket based on the polarity requested by the type of electrode used.
- Connect the plug of the ground clamp to the welding socket on the basis of the polarity required.
- Connect the ground terminal to the workpiece being processed.
- Connect the compressed air supply hose to the electrode holder.



DANGER!

Electric shock hazard!

Read the warnings highlighted by the following symbols in the “General instructions for use”.



10. Set the current generator ON/OFF switch to “I” (unit powered).

The system is ready to start gouging.

2 USER INTERFACE

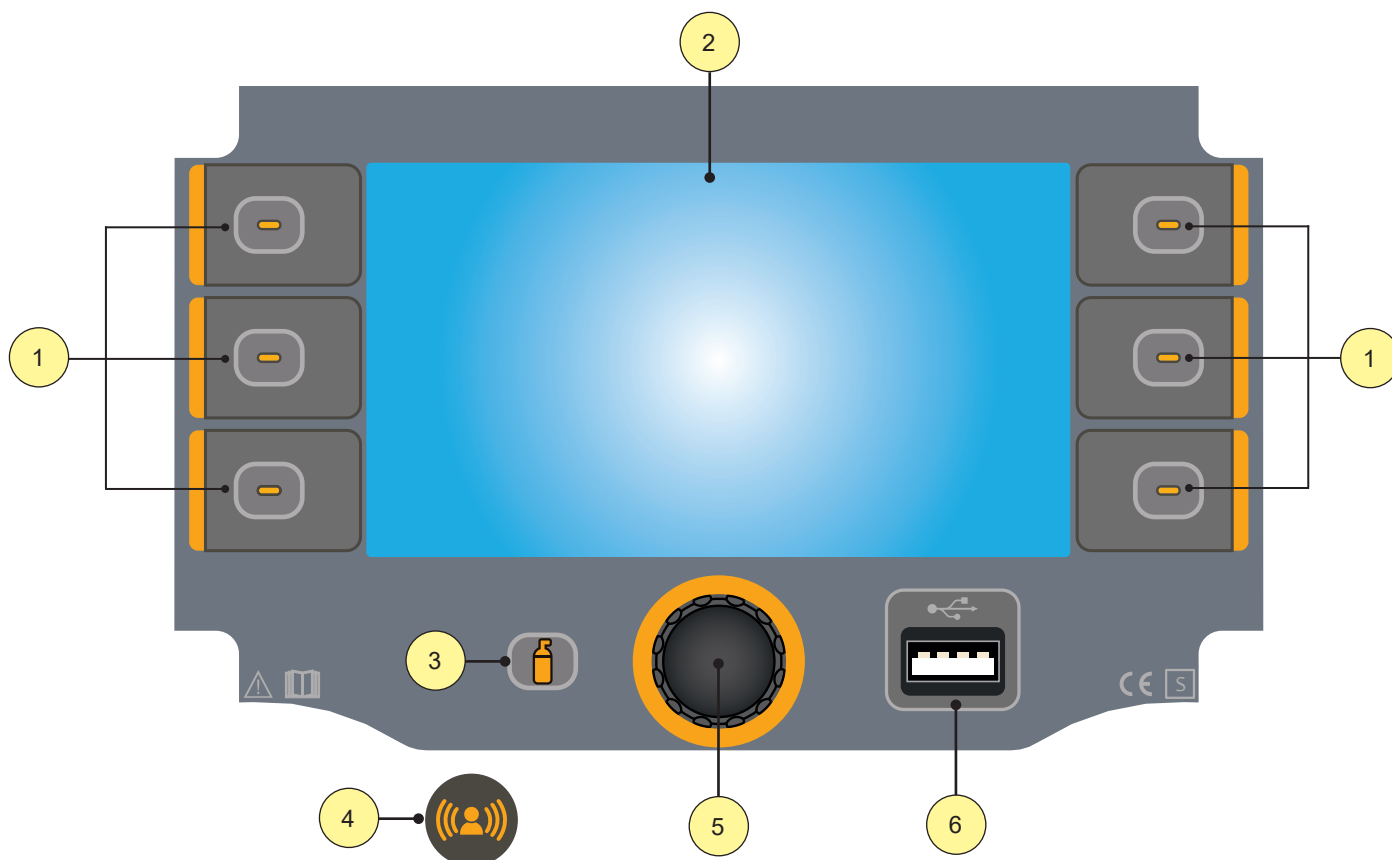

ELEMENT	FUNCTION
1	<p>Multi-function buttons</p> <p>These keys are assigned specific functions that vary depending on the menu and settings screens you are in. The function assigned to each key is identified by the icon that appears next to it.</p>
2	<p>7" colour touch screen display</p> <p>The display shows the menus for setting up the welding machine and its functions. During welding, the display shows the set welding parameters.</p>
3	<p>GAS key</p> <p>Pressing the key activates the gas solenoid valve to fill the circuit and calibrate the flow pressure with the regulator located in the gas cylinder or in the centralised system.</p>
4	<p>NFC key reader</p> <p>By holding an NFC key near the area identified by this symbol, it is possible lock and unlock the device and perform user authentication. Each user is only enabled for the functions specified by the device administrator.</p>
5	<p>Encoder with integrated key</p> <p>In the menu screens, the encoder scrolls through the list of parameters/settings. Pressing the encoder selects the highlighted setting. During welding, the encoder changes the value of the active parameter.</p>
6	<p>USB port</p> <p>Used to connect a USB memory stick to export/import JOBS and system parameters. The USB port is also used to update the machine's system firmware.</p>

ENGLISH

2.1 MAIN SCREEN

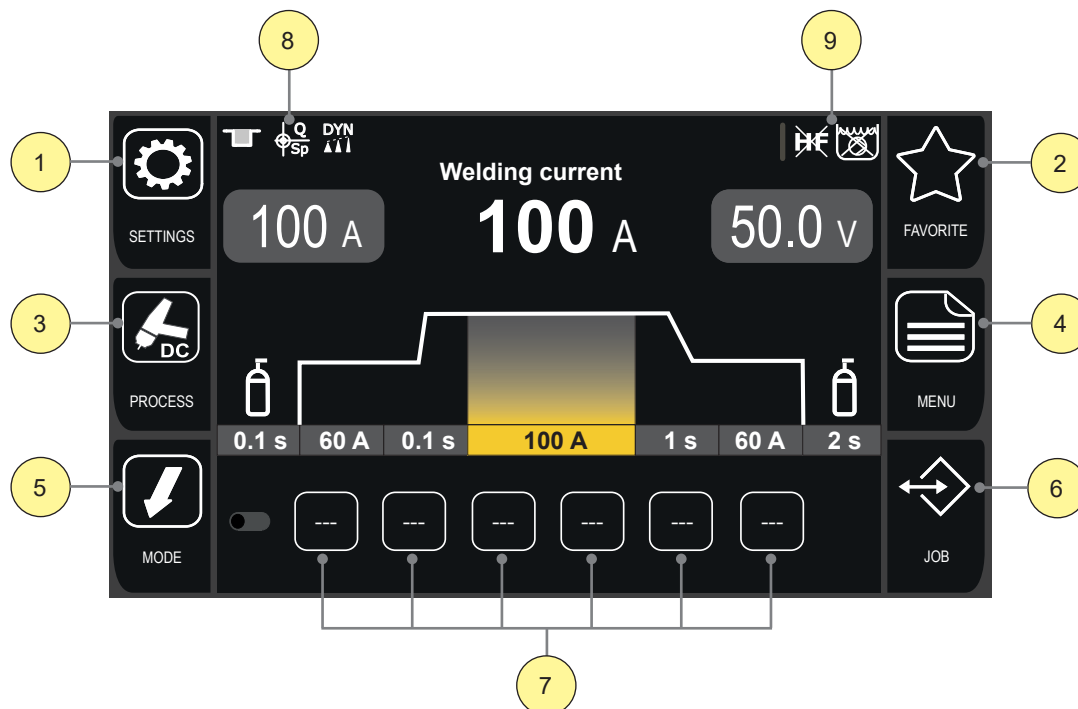

ELEMENT	FUNCTION
1	In TIG mode, the [SETTINGS] key accesses a sequence of screens through which it is possible to program the parameters needed to define the welding curve. In MMA mode, the [SETTINGS] key displays the screen to select the electrode material type.
2	The [FAVORITE] key gives access to the BUTTON menu by means of which it is possible to associate a specific function to the [SHORTCUT] keys, among those available.
3	The [PROCESS] key allows for the welding process to be selected. The processes that can be selected are: TIG DC, MMA, ARC AIR.
4	The [MENU] key gives access to the menu by means of which the main characteristics of the weld are set. It also contains special functions such as: welding circuit calibration, system menu, import/export.
5	The [MODE] key gives access to the menu by means of which the torch trigger mode is selected.
6	The [JOB] key gives access to the JOB management menu.
7	The [SHORTCUT] keys allow direct access to the function assigned by the user. Pressing the key activates the assigned function (the key's background is highlighted). Pressing the key again deactivates the function. It only works with the touch screen. Press and hold the desired [SHORTCUT] key for 3 seconds to directly enter the function assignment screen.
8	Notification bar: area dedicated to the welding settings.
9	Notification bar: area dedicated to the system settings.

2.2 WELDING PARAMETERS SETTING

The welding parameters are displayed in the central box of the screen. They can be selected and modified directly from the main screen using the encoder with a key.

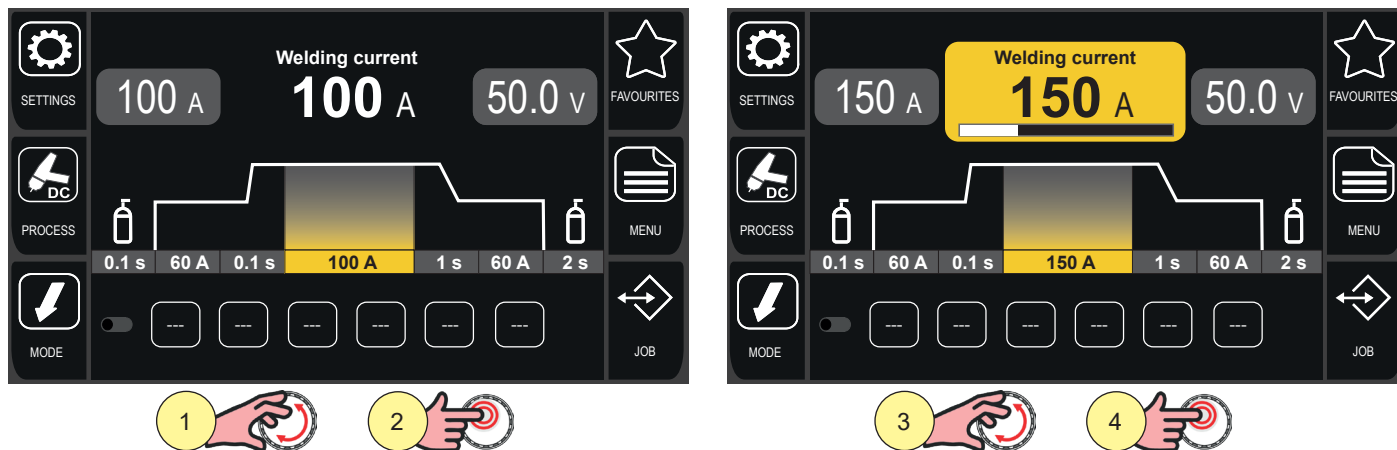



















1. Turn the encoder to select the parameter to be modified: the list of parameters that can be modified is displayed in sequence.
2. Press the [ENCODER] key; the background of the box will change colour.
3. Turn the encoder to set the desired value.
4. Press the [ENCODER] key again to re-select the parameters.

The parameters that can be changed from the main screen can be selected by the user through the Display Setup menu.

The changeable parameters are listed in the following table.

ENGLISH

SYMBOL	DESCRIPTION	PROCESS		
		TIG DC	MMA	ARC AIR
	Welding current [A] Sets the welding current.	■	■	■
	Pregas [s] Sets the gas flow time from the torch before the arc is ignited.	■		
	Starting current [%] Current value delivered by the equipment immediately after the welding arc is ignited. The parameter value can be set as a percentage of the welding current.	■		
	Slope 1 [s] Time in which the current slopes from the starting current to the welding current.	■		
	Blevel [%] Secondary welding current value, activated by quickly pressing and releasing (less than 0.5 seconds) the torch key during welding. The parameter value can be set as a percentage of the welding current.	■		
	Slope 2 [s] Time during which the current changes from the welding value to the end value by means of a slope.	■		
	Final current [%] The parameter value can be set as a percentage of the welding current.	■		
	Postgas [s] Sets the gas flow time from the torch after the arc is extinguished.	■		
	Job Used to select a job previously saved by the user.	■	■	■
	Diameter [mm] Sets the electrode diameter to optimise ignition of the welding arc.	■		
	Qspot [On / Off] Activates the Q-SPOT function.	■		
	Qstart [On / Off] Activates the Q-START function.	■		
	Pulse [On / Off] Activates the pulsed mode.	■		
	MPulse [On / Off] Activates the multiple pulsed mode.	■		
	Dynamics Activates the dynamic mode (in the pulsed process) which is used to correct the energy of the pulsed arc pulses.	■		

SYMBOL	DESCRIPTION	PROCESS		
		TIG DC	MMA	ARC AIR
	Arc Force [%] This parameter helps to avoid electrode sticking during welding. It is set as a percentage of the welding current.		■	
	Dynamics (in the electrode welding process) Conditions the short-circuit energy at the time of drop detachment		■	
DC₊	Polarity This parameter is used to select the appropriate welding polarity (DC+, DC-, AC) for the electrode being welded, in accordance with the consumable manufacturer's specifications. When AC polarity is selected, the sinusoidal wave frequency can be set via the special functions menu.		■	
	Hot start This parameter aids electrode melting at the time of arc ignition. It is set as a percentage of the welding current.		■	

ENGLISH

2.3 SPECIAL FUNCTION PARAMETERS SETTING

At the bottom of the display, by clicking the icon , it is possible to open the quick settings menu for the special function parameters.

The boxes displayed vary depending on the special functions that have been activated.

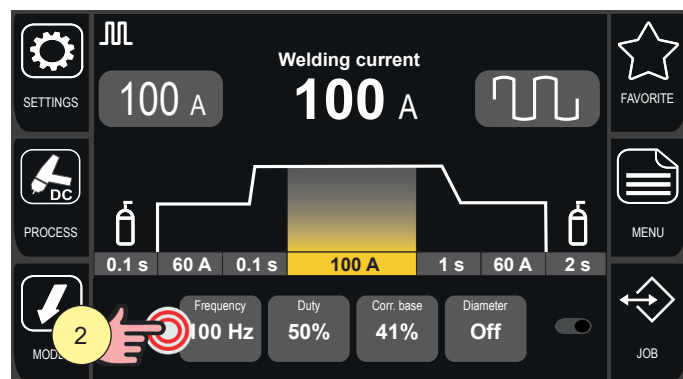
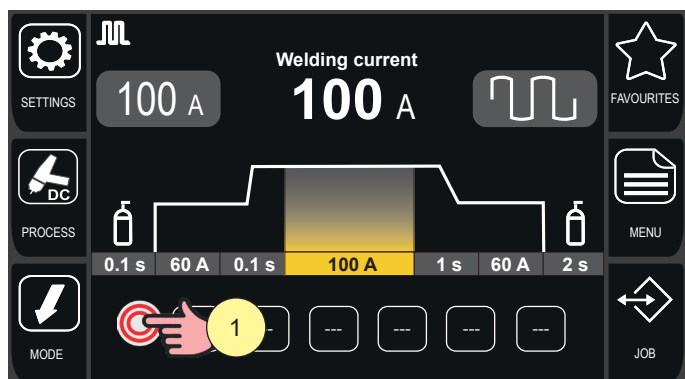

1. Click the icon : the parameters available for setting are displayed.
2. Click the box corresponding to the setting to be changed.
The box's background colour changes and the parameter becomes user-editable.

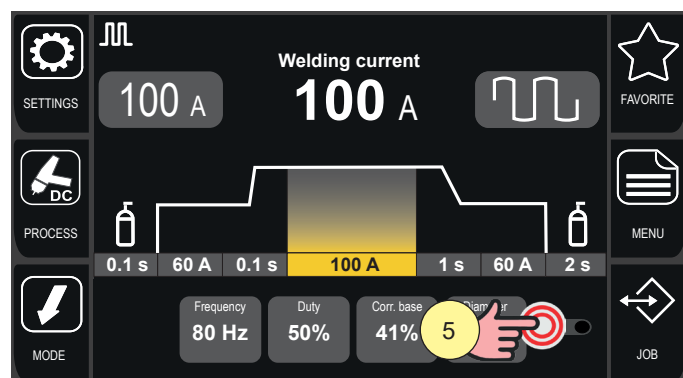
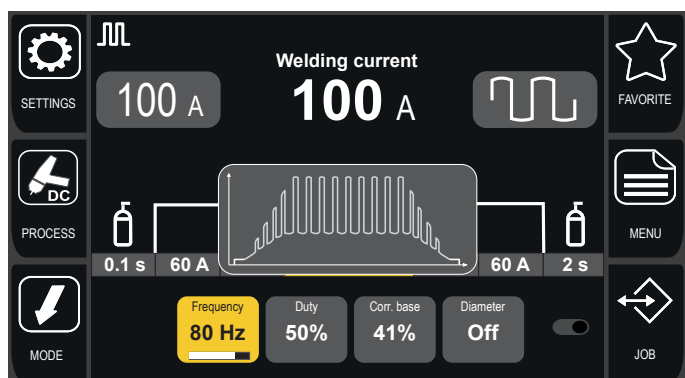

3. Turn the encoder to set the desired value.
4. Press the [ENCODER] key again to confirm the setting.
5. Click the icon  to close the quick settings menu.

2.4 SIMPLIFIED INTERFACE

It is possible to activate the simplified display interface, thereby being able to view the welding parameter graph across the full screen.

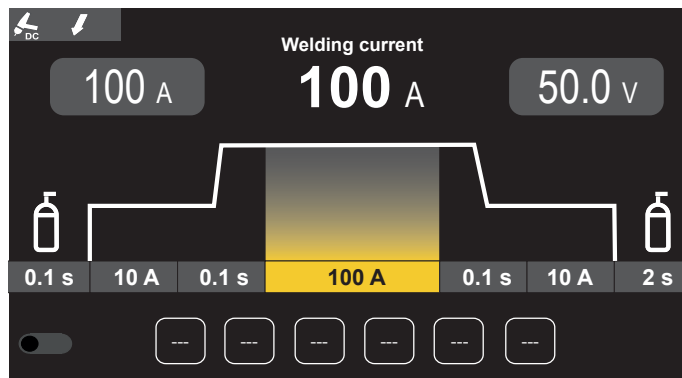
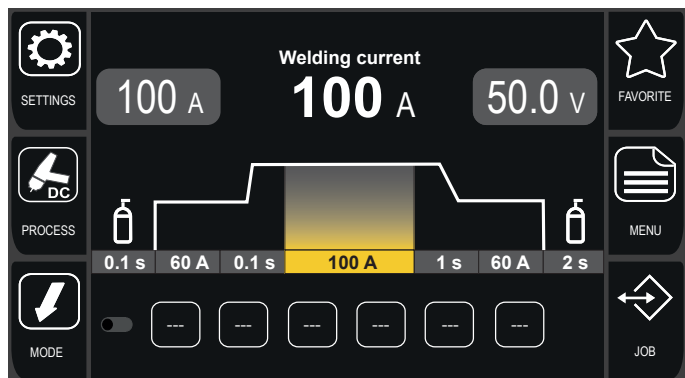

1. Press and hold the [ENCODER] key for 3 seconds.
The display automatically switches to the simplified interface.
2. To return to the default interface, press and hold the [ENCODER] key again for 3 seconds.

i Information When the simplified interface is active, icons indicating the currently selected process type and torch trigger mode are displayed in the upper left corner.

ENGLISH

3 PRELIMINARY SETTINGS

3.1 LANGUAGE SETTING

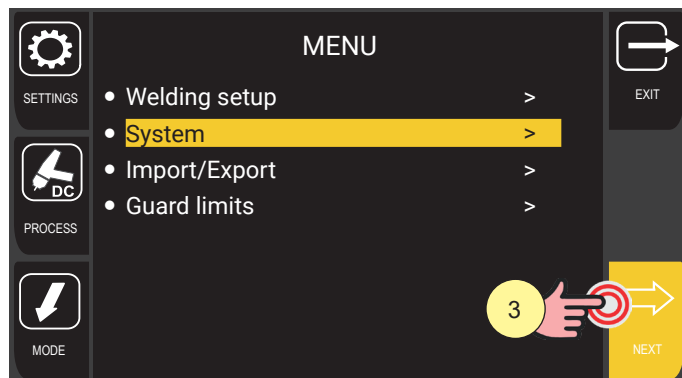
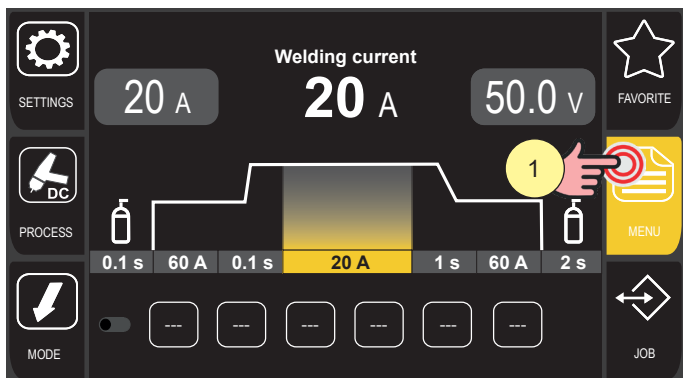

1. Press the [MENU] key.
2. Turn the encoder to select the desired setting.
Select the following path: System>
3. Press the encoder key or the [NEXT] key to confirm.

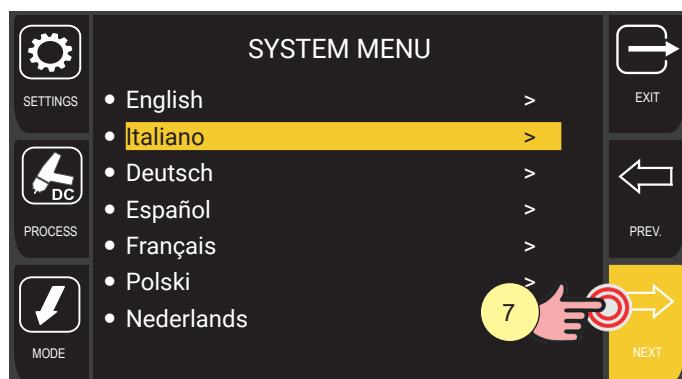
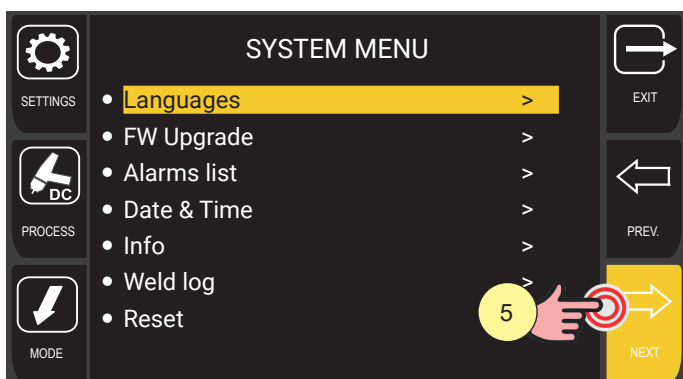

4. Turn the encoder to select the desired setting.
5. Select the following path: Languages>
6. Press the encoder key or the [NEXT] key to confirm.
7. Turn the encoder to select the desired language.
8. Press the encoder key or the [NEXT] key to confirm.
9. Press the [EXIT] key to exit the screen.

3.2 FIRMWARE UPGRADE

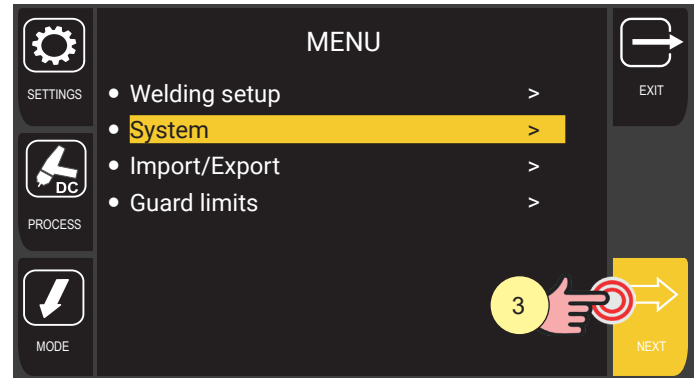
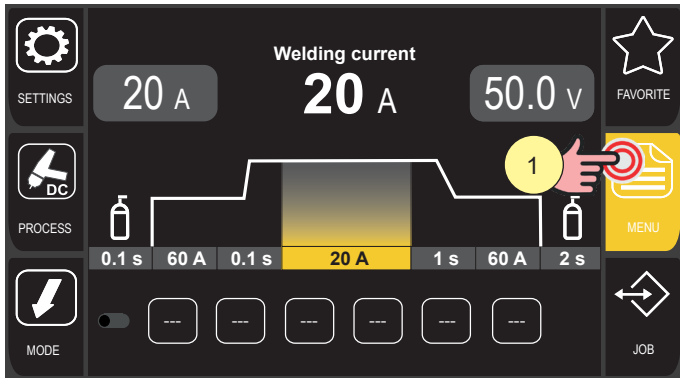

1. Press the [MENU] key.
2. Turn the encoder to select the desired setting.
Select the following path: System>
3. Press the encoder key or the [NEXT] key to confirm.

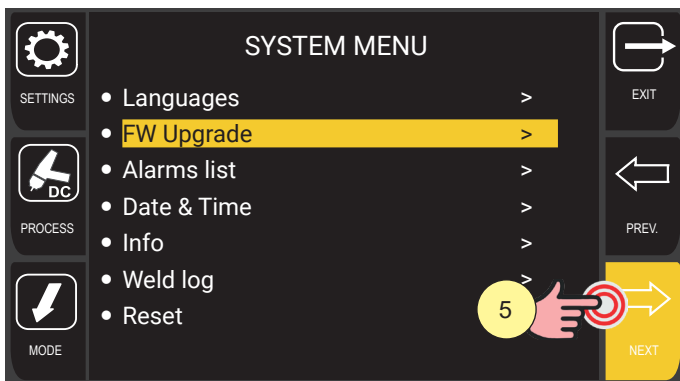

4. Turn the encoder to select the desired setting.
Select the following path: FW Upgrade>
5. Press the encoder key or the [NEXT] key to confirm.
6. Insert the USB pen drive with the firmware loaded into the appropriate port on the front panel of the machine.

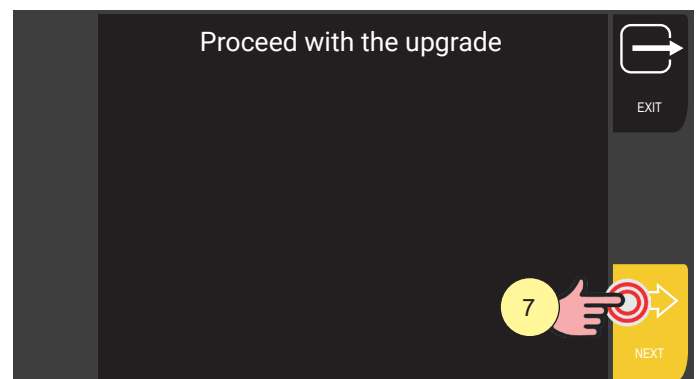
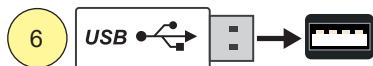

7. Press the [NEXT] key.

ENGLISH

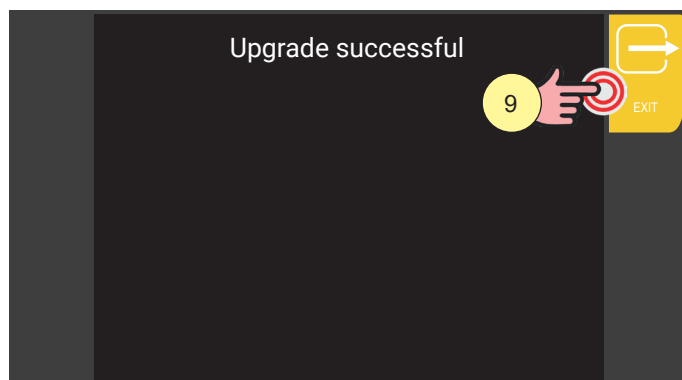
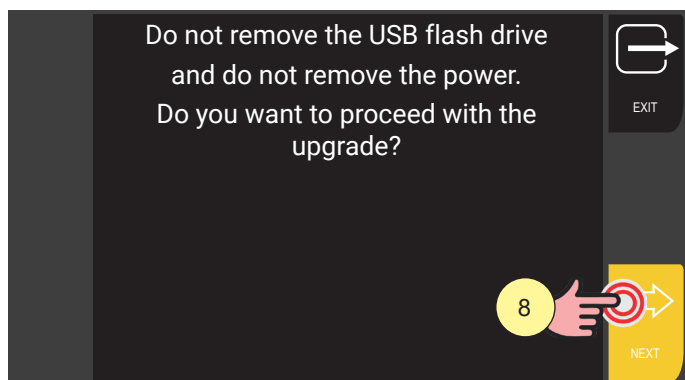

8. Press the [NEXT] key.
Press the [EXIT] key to go back to the main screen.
Wait for the update procedure to finish.
9. Press the [EXIT] key.

If problems are found in the upgrade, the display shows a notice.

NOTICE	MEANING
Release file not found	File not present in the USB pen drive.
No USB/SD card found	USB pen drive not recognised (there isn't one or it is inserted incorrectly). Check the correct insertion of the USB pen drive. Use a different USB pen drive.
Could not decrypt release file	File corrupt or with changed name (never rename the provided update file).
Could not inflate release file	File corrupt or with changed name (never rename the provided update file).
Update directory and/or script not found	File corrupt or with changed name (never rename the provided update file).
Update procedure failed	Contact the customer service.
Upgrade package is not for this board	The file uploaded to the USB pen drive is not compatible with the electronic board.
Could not find readme file not found in upgrade package	Contact the customer service.
Installed version and upgrade package version do not match	You cannot downgrade the installed software.
Could not upgrade generator	Contact the customer service.

3.3 DATE AND TIME SETTING

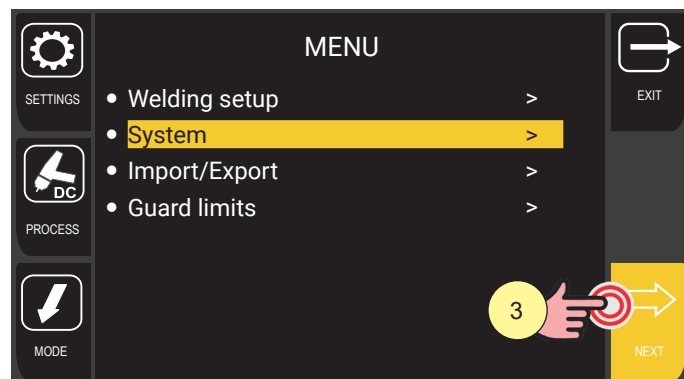
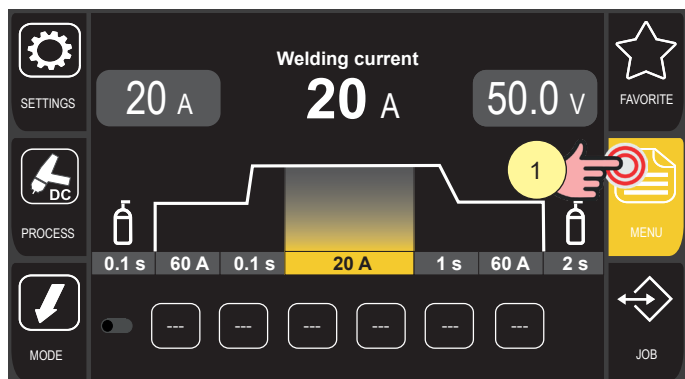

1. Press the [MENU] key.
2. Turn the encoder to select the desired setting.
Select the following path: System>
3. Press the encoder key or the [NEXT] key to confirm.

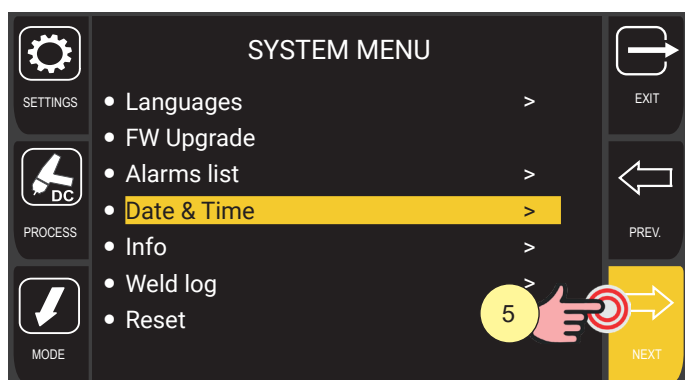

4. Turn the encoder to select the desired setting.
Select the following path: Date & Time>
5. Press the encoder key or the [NEXT] key to confirm.

ENGLISH

Time zone setting

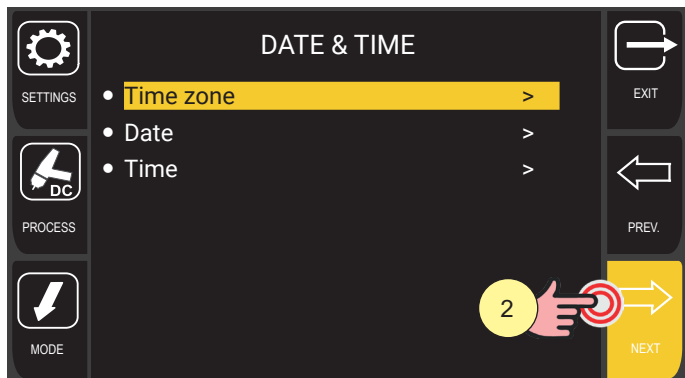

1. Turn the encoder to select the desired setting.
Select the following path: Time zone>
2. Press the encoder key or the [NEXT] key to confirm.
3. Turn the encoder to select the desired time zone.
4. Press the encoder key or the [NEXT] key to confirm.

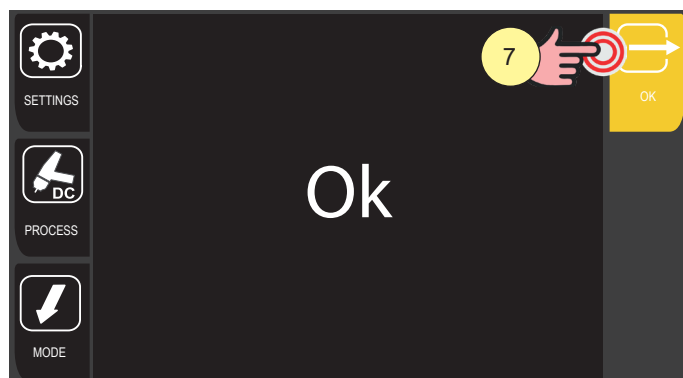

5. Turn the encoder to select the desired city.
6. Press the encoder key or the [SAVE] key to confirm.
7. Press the [OK] key to confirm and exit the screen.

Date setting

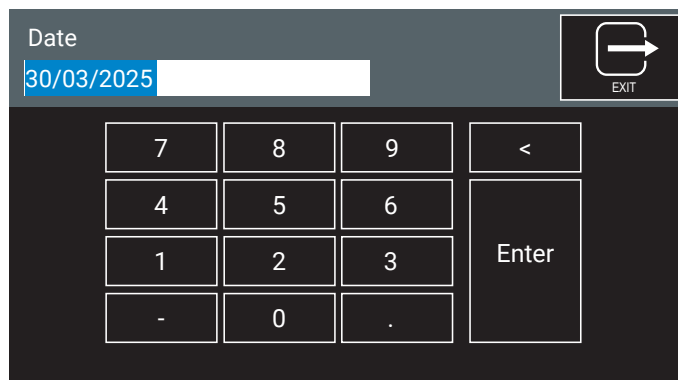
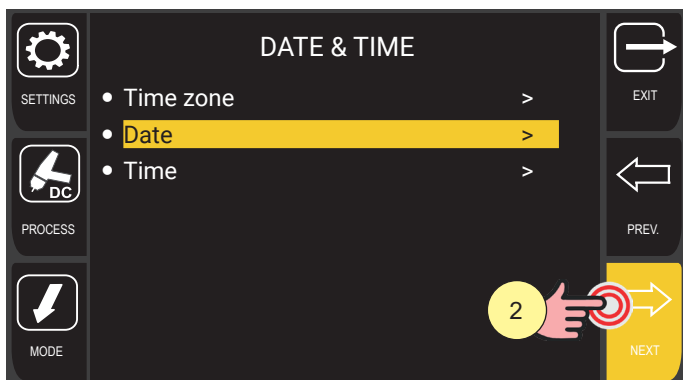

1. Turn the encoder to select the desired setting.
Select the following path: Date>
2. Press the encoder key or the [NEXT] key to confirm.
i Information The panel is of the touch screen type; settings can be made both by means of the mechanical keys and by touching the icons that appear on the screen.
3. Turn the encoder to select the number on the keyboard.
4. Press the encoder key to confirm the selection.



5. Turn the encoder to select the [ENTER] symbol on the keyboard.
6. Press the encoder key to confirm.
A check mark appears to confirm the operation.
7. Press the [EXIT] key to exit the screen.

ENGLISH

Time setting

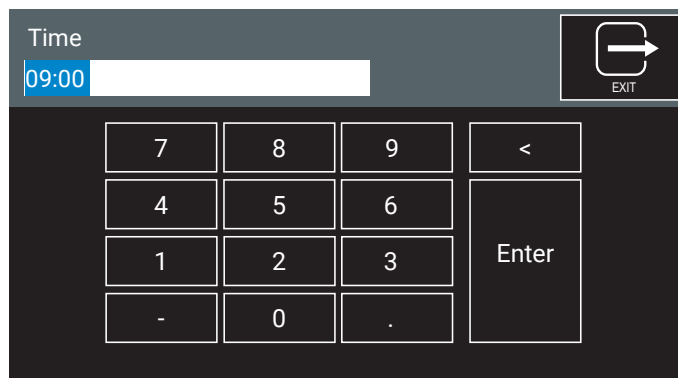
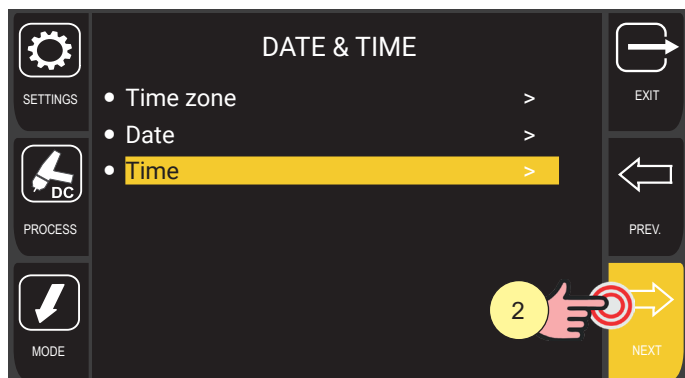

1. Turn the encoder to select the desired setting.
Select the following path: Time>
2. Press the encoder key or the [NEXT] key to confirm.
i Information The panel is of the touch screen type; settings can be made both by means of the mechanical keys and by touching the icons that appear on the screen.
3. Turn the encoder to select the number on the keyboard.
4. Press the encoder key to confirm the selection.



5. Turn the encoder to select the [ENTER] symbol on the keyboard.
6. Press the encoder key to confirm.
A check mark appears to confirm the operation.
7. Press the [EXIT] key to exit the screen.

3.4 SYSTEM SETTINGS

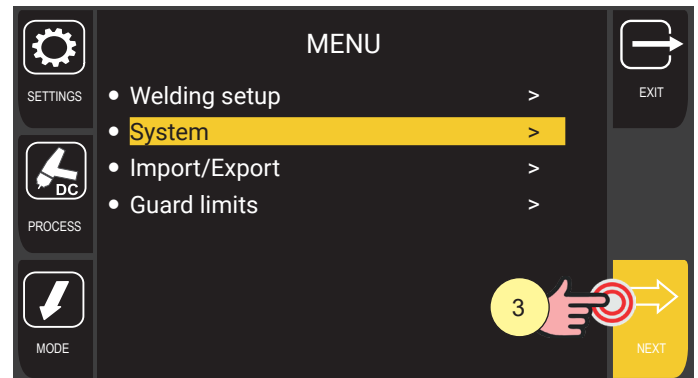
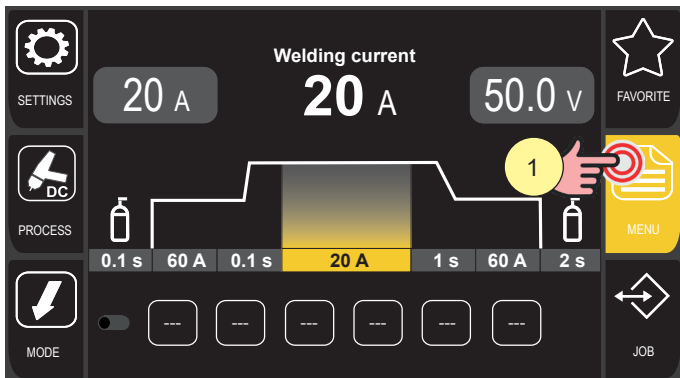

1. Press the [MENU] key.
2. Turn the encoder to select the desired setting.
Select the following path: System>
3. Press the encoder key or the [NEXT] key to confirm.

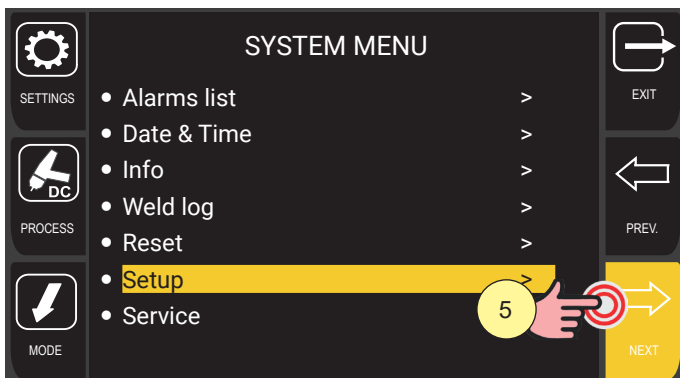

4. Turn the encoder to select the desired setting.
Select the following path: Setup>
5. Press the encoder key or the [NEXT] key to confirm.
It is possible to access the setup menus described in the following paragraphs.

ENGLISH

3.4.1 HF Setup

This menu is used to set the operation of the high frequency (HF) ignition of the welding arc.

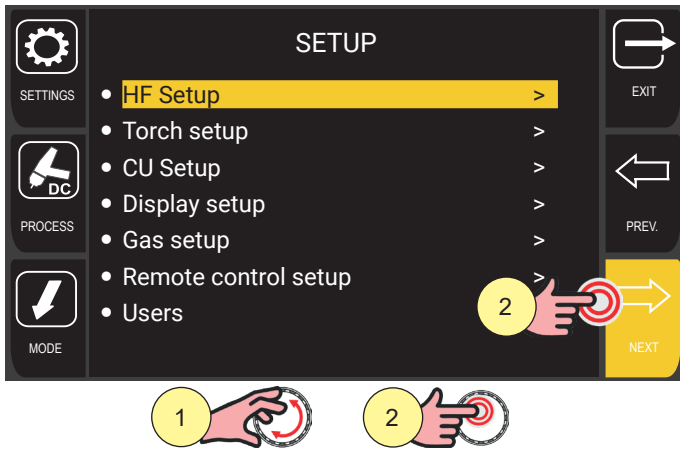

1. Turn the encoder to select the desired setting.
Select the following path: HF setup>
2. Press the encoder key or the [NEXT] key to confirm.

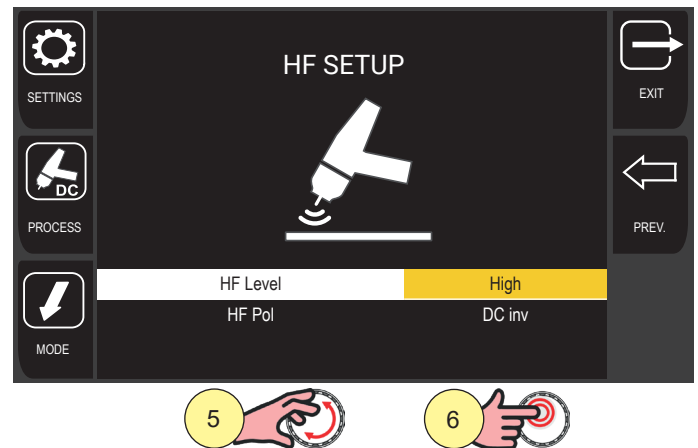
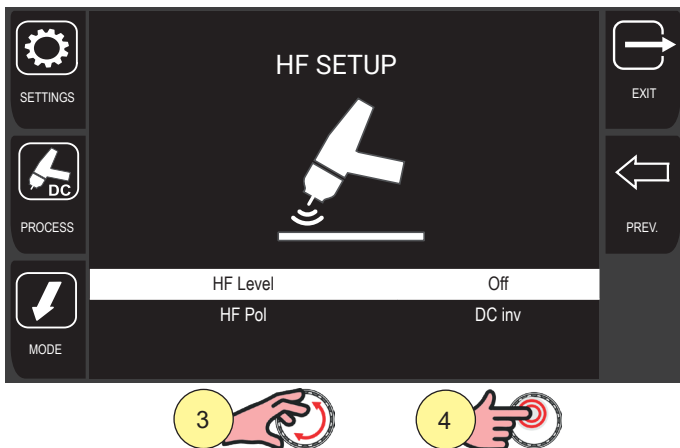

3. Turn the encoder to select the parameter to be modified
4. Press the encoder key to activate parameter change.
The parameter background is highlighted.
5. Turn the encoder to select the desired setting.
6. Press the encoder key to confirm the setting change.
The parameter background is no longer highlighted.

The adjustable parameters are described below.

HF Level

This parameter is used to set the voltage level for high-frequency ignition. When the value is set to "Off," the welding arc is ignited in "Lift" mode.

Adjustment range: minimum (Off) - default (Medium) - maximum (High)

Consequences of a higher value:

- The welding arc is easy to ignite even on very dirty workpieces.
- There is a risk of perforating the sheet metal if the thickness is too thin.

HF ignition occurs through a high-voltage, low-amperage electrical discharge between the tip of the electrode and the workpiece. Once the electric arc is established, the generator stops delivering the HF discharge. This type of ignition, in addition to being very easy and immediate, extends the life of the electrode and keeps it very pure, allowing the operator to work with a very precise and stable arc.

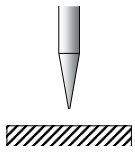
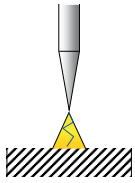
HF ARC IGNITION PROCEDURE		
1		Place the tungsten electrode on the ignition point, so that there is a distance of approximately 2-3mm between the electrode and the workpiece.
2		Press the torch trigger according to the selected mode. The arc ignites without touching the workpiece.

Arc ignition in LIFT mode is created by a low-amperage short circuit (to prevent damage to the electrode) that the operator creates between the tip of the electrode and the workpiece, causing the electrode tip to rise, maintaining the flow of current, creating the so-called electric arc. It is advisable to use LIFT ignition when welding near machinery, printed circuit boards, and electronic components.

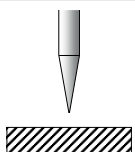
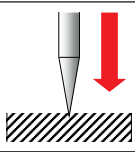
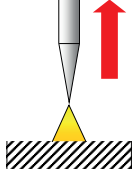
ARC IGNITION PROCEDURE IN LIFT-ARC		
1		Place the tungsten electrode on the ignition point, so that there is a distance of approximately 2-3mm between the electrode and the workpiece.
2		Touch the workpiece with the electrode and press the torch trigger according to the selected mode.
3		Raise the torch to ignite the arc.

When HF ignition is disabled, the icon  appears on the display.



ENGLISH

HF Polarity

This parameter is used to set the polarity of the high-frequency ignition to better suit the type of welding being performed.

Adjustment range: value 1 (DC dir) - value 2 (DC inv) - default (DC dir)

3.4.2 Torch setup

This menu is used to configure the operation of the secondary torch triggers, when using torches equipped with a second button and up/down buttons.

This way, the main torch trigger can be dedicated exclusively to the start and end of welding function.

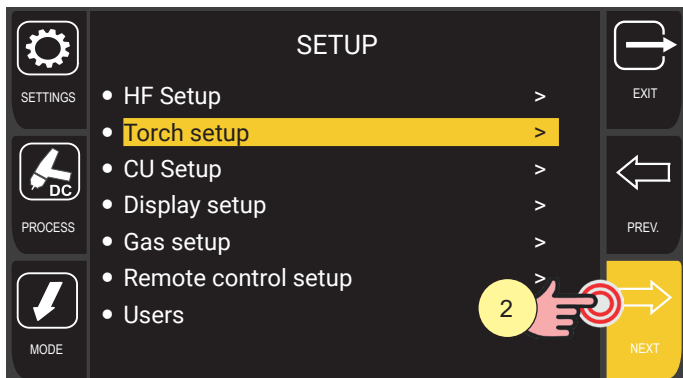

1. Turn the encoder to select the desired setting.
Select the following path: Torch setup>
2. Press the encoder key or the [NEXT] key to confirm.

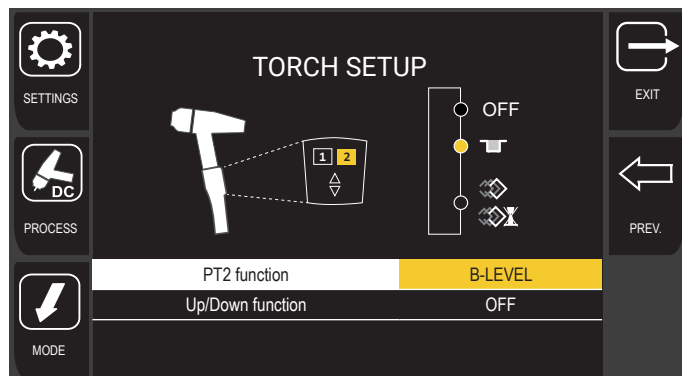
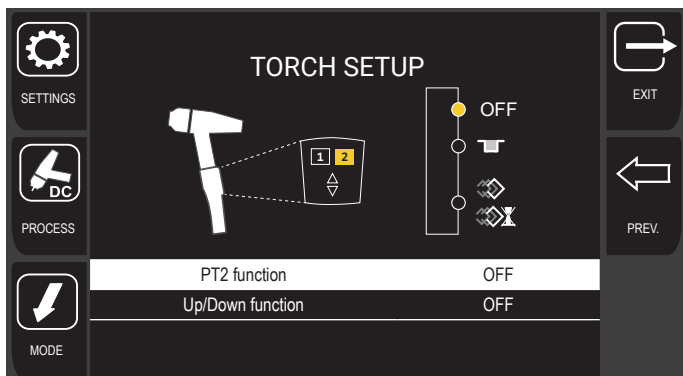

3. Turn the encoder to select the parameter to be modified
4. Press the encoder key to activate parameter change.
The parameter background is highlighted.
5. Turn the encoder to select the desired setting.
 - **OFF**: No function is matched with the key.
 - **B-LEVEL**: The key is associated with the activation of the B-Level function.
 - **JOB SEL**: The job selection function is associated with the key.
6. Press the encoder key to confirm the setting change.
The parameter background is no longer highlighted.

ENGLISH

3.4.3 Cooling unit setup

This menu is used to set the operation of the cooling unit.

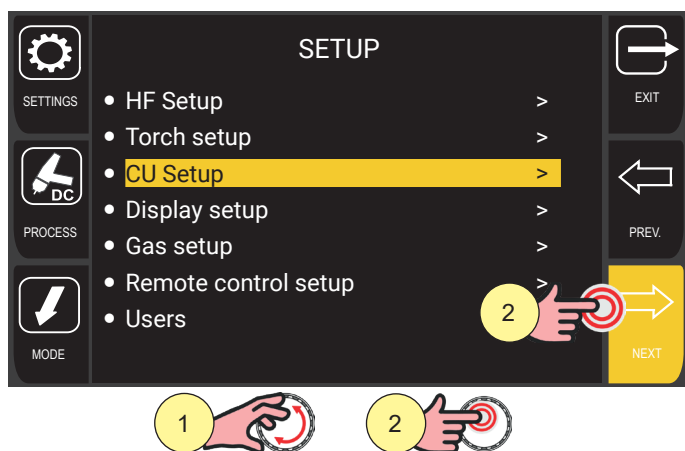

1. Turn the encoder to select the desired setting.
Select the following path: CU setup>
2. Press the encoder key or the [NEXT] key to confirm.

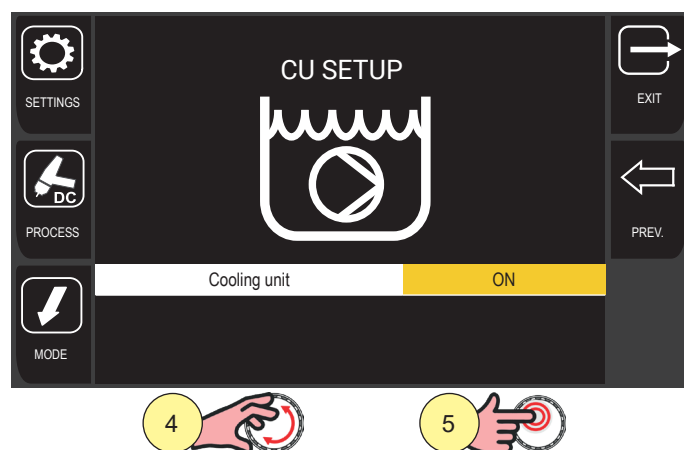
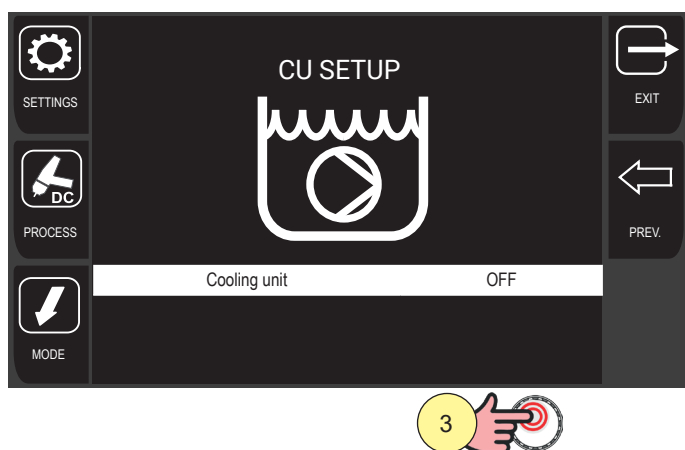

3. Press the encoder key to activate the parameter change.
4. Turn the encoder to select the desired setting.
 - **AUTO**: When the unit is switched on, the cooling system is switched on for 30 s. During welding procedures, the cooling system runs constantly. At the end of welding, the unit remains on for a predefined time.
 - **ON**: The cooling system is always running when the current generator is switched on. This mode is preferable for heavy duty and automatic welding procedures.
 - **OFF**: The cooling unit is always disabled; to be selected if you are using an air-cooled torch.
5. Press the encoder key to confirm.
6. Press the [EXIT] key to exit the screen

When the cooling unit is deactivated, the display shows the icon 

3.4.4 Display setup

Using the Display Setup menu, it is possible to change the display of welding parameters and shortcut keys on the main display screen.

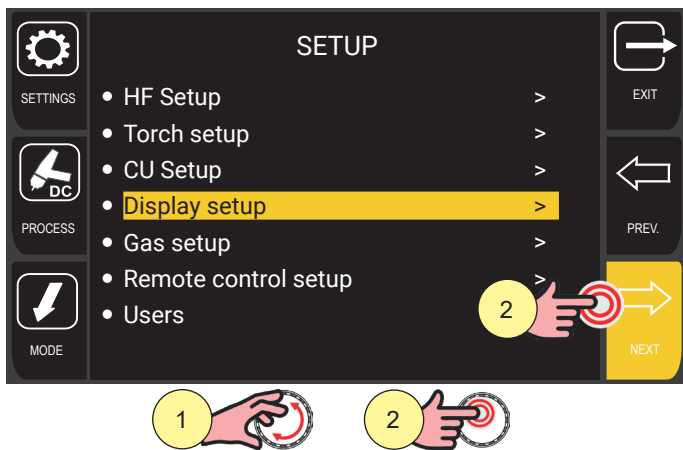

1. Turn the encoder to select the desired setting.
Select the following path: Display setup>
2. Press the encoder key or the [NEXT] key to confirm.

Welding parameters

The menu is used to select which parameters to display in the central pane of the main screen, so that the user can modify them simply by using the encoder with a key (see section 2.2).

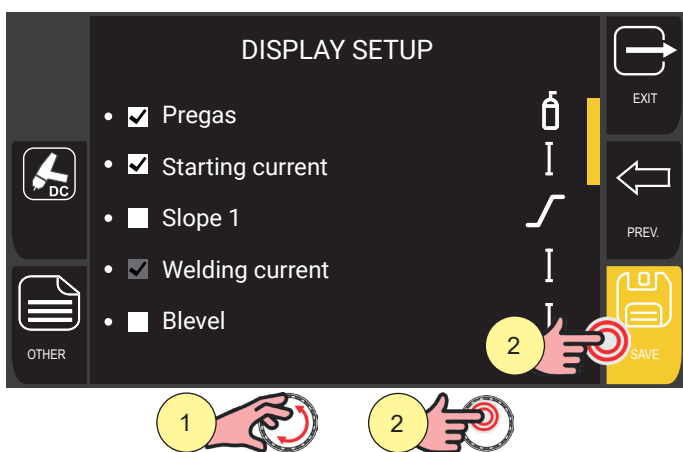
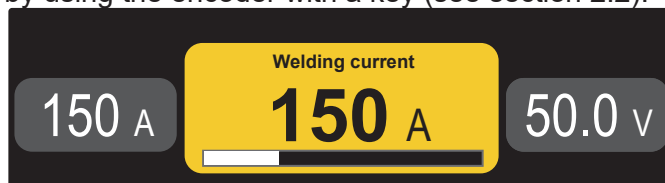

1. Rotate the encoder to select the desired parameters.
2. Press the encoder key or the [SAVE] key to confirm.
It is possible to select multiple parameters to be displayed by repeating steps 3 and 4.
If a parameter is displayed by default, its checkbox is greyed out and cannot be deselected.

Press the [EXIT] key to exit the screen.

ENGLISH

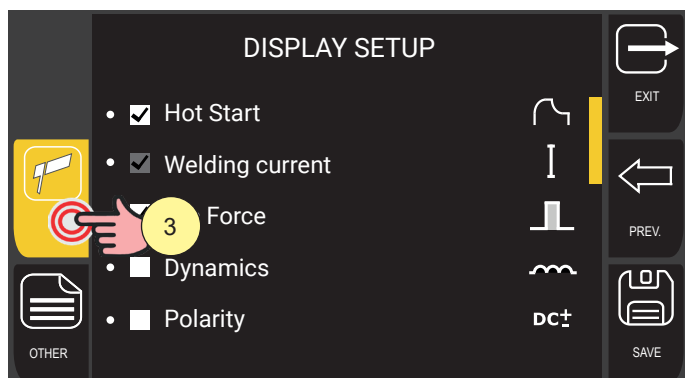

- The parameters that can be displayed are related to the welding process. Repeatedly pressing the process selection key scrolls through the various display setup screens with process-specific parameters.

Number of favorite keys

It is possible to change the number of shortcut keys displayed at the bottom of the screen (see section 7).

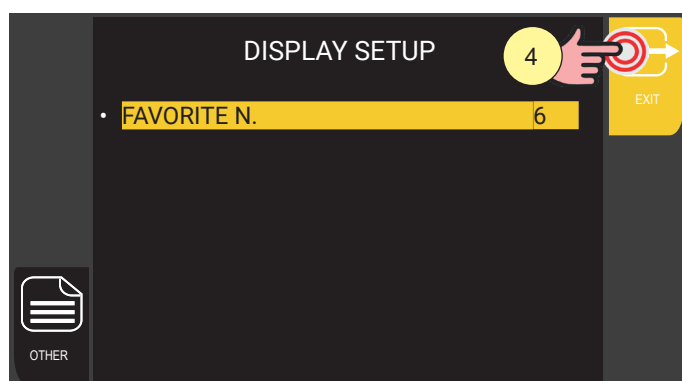
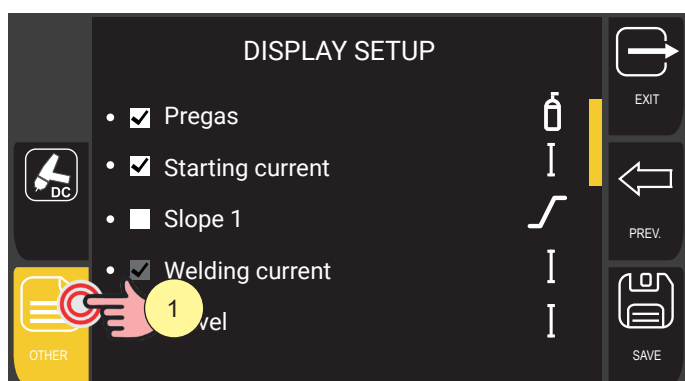

- Press the [OTHER] key.
- Press the encoder key to activate parameter change.
The parameter background is highlighted.
- Turn the encoder to set the desired value.
Adjustment range: minimum (1) - maximum (6) - default (6)
- Pressing the [EXIT] key exits the screen and saves the settings.

3.4.5 Gas setup

On generators equipped with a double solenoid valve for gas supply, it is possible to connect two different types of gas from different sources.

The gas setup menu allows the user to choose which solenoid valve will deliver gas during the various welding phases.

 **NOTICE!** Correctly connect the gas supply pipes to the fittings marked 1 and 2 on the generator. When setting the gas supply, always check which type of gas is connected to solenoid valves 1 and 2.

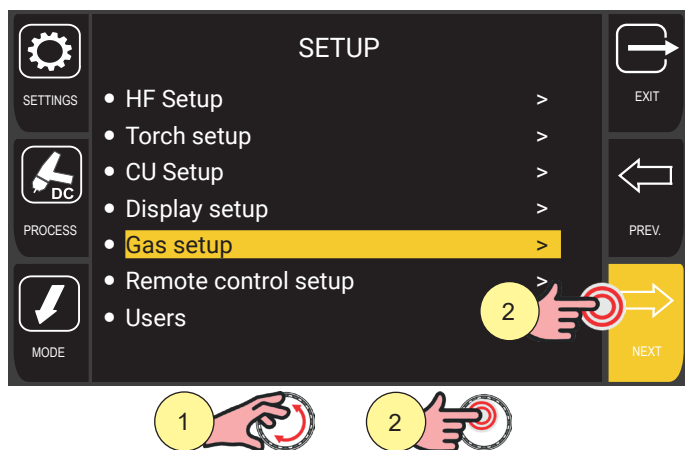

1. Turn the encoder to select the desired setting.
Select the following path: Gas setup>
2. Press the encoder key or the [NEXT] key to confirm.

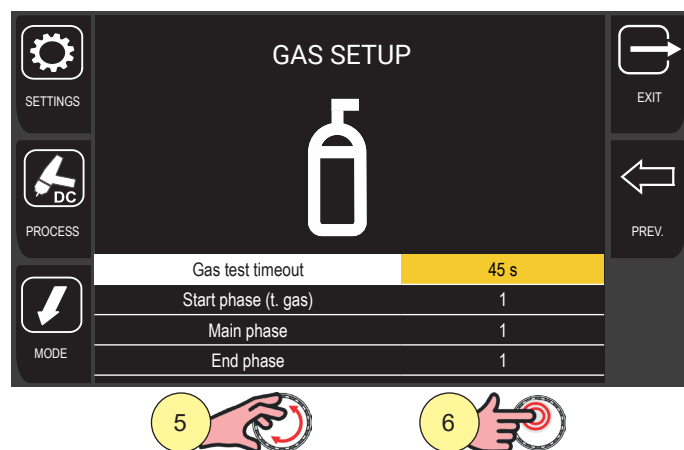
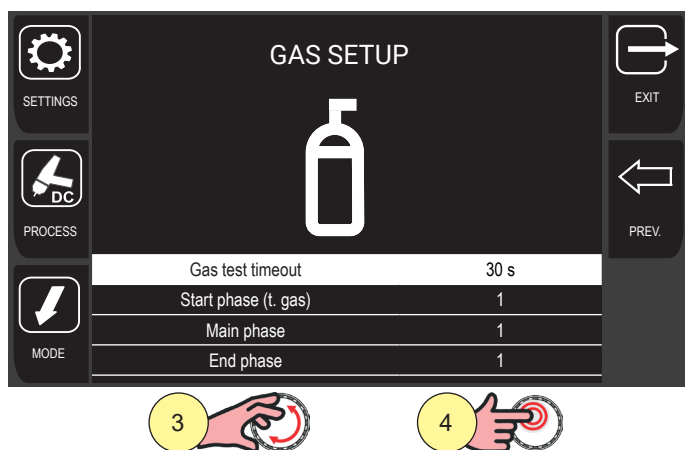

3. Turn the encoder to select the parameter to be modified
4. Press the encoder key to activate parameter change.
The parameter background is highlighted.
5. Turn the encoder to set the desired value.
6. Press the encoder key to confirm the setting change.
The parameter background is no longer highlighted.

ENGLISH

The adjustable parameters are described below.

Gas test timeout

This parameter defines the time in seconds of the gas test, which is performed when the user presses the  key on the machine's front panel.

Adjustment range: minimum (1 s) - maximum (1 h) - default (30 s)

Start phase (gas test)

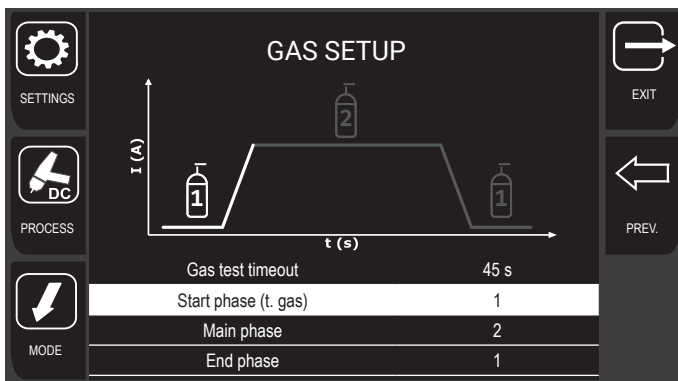

This parameter defines which solenoid valve supplies gas during the initial phase of welding and in the gas test.

Adjustment range: value 1 (1) - value 2 (2) - default (1)

Main phase

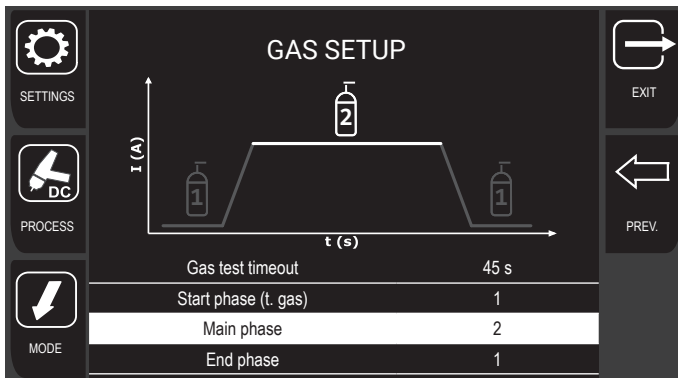

This parameter defines which solenoid valve supplies gas during the main phase of welding.

Adjustment range: value 1 (1) - value 2 (2) - default (1)

End phase

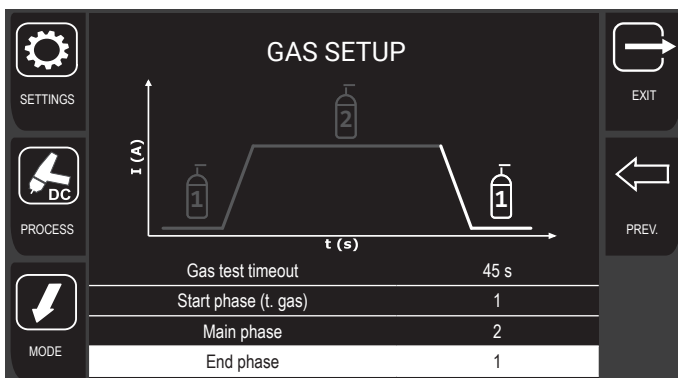

This parameter defines which solenoid valve supplies gas during the end phase of welding.

Adjustment range: value 1 (1) - value 2 (2) - default (1)

3.4.6 Remote control setup

This menu is used to manage the remote control operation.

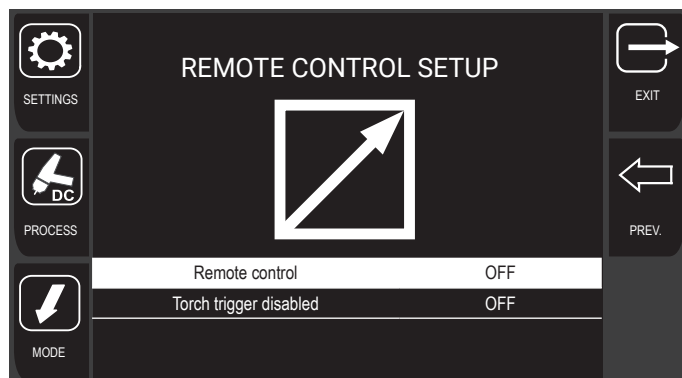
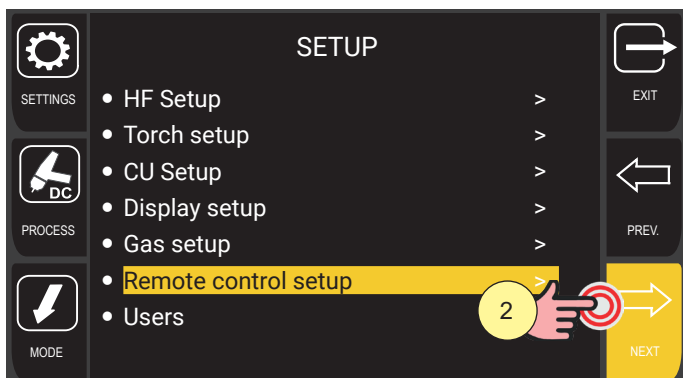

1. Turn the encoder to select the desired setting.
Select the following path: Remote control setup
2. Press the encoder key or the [NEXT] key to confirm.
3. Turn the encoder to select the desired setting.
4. Press the encoder key to activate parameter change.
The parameter background is highlighted.

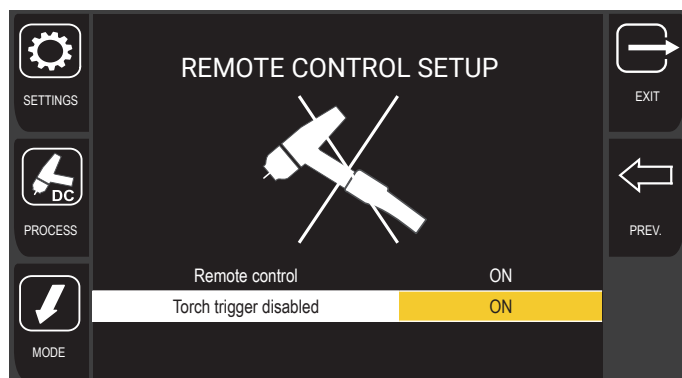
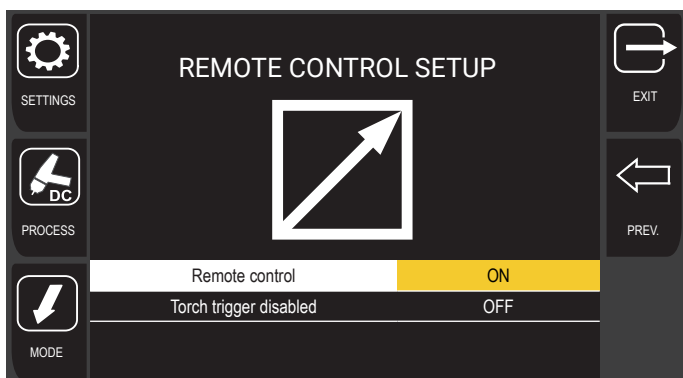

5. Turn the encoder to select the desired setting.
 - **REMOTE CONTROL:** enables the remote pedal control.
 - **TORCH TRIGGER DISABLED:** disables the torch trigger on the remote pedal control; this option is useful when the operator wants to use the pedal exclusively for current regulation (excluding the start and end of welding commands).
6. Press the encoder key to confirm.
7. Press the [EXIT] key to exit the screen.

When the remote pedal control is connected but not activated, the icon  appears on the display.

When the remote pedal control is connected and activated, the icon  appears on the display.

ENGLISH

When the remote pedal control is being used, the main display changes, leaving only the current intensity as the only parameter that can be changed by the user.

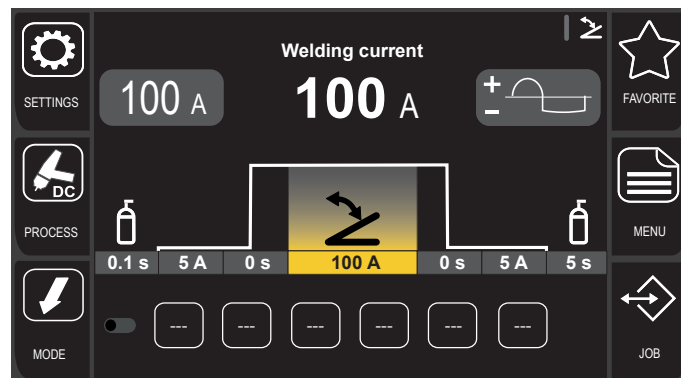

Press the trigger on the torch to return to the standard display.

3.5 IMPORT/EXPORT SETTINGS

The following operating parameters can be imported or exported using the [IMPORT/EXPORT] menu:

- Jobs: imports/exports jobs
- Parameters: imports/exports the equipment's operating parameters
- Display: imports/exports the display setup
- Language: imports/exports the display language setup
- Users: imports/exports the user setup

NOTICE! For correct import/export, it is advisable to use a USB pen drive that does not contain other files in the root folder. Otherwise, the first import file found in the root folder, alphabetically sorted, will be used.

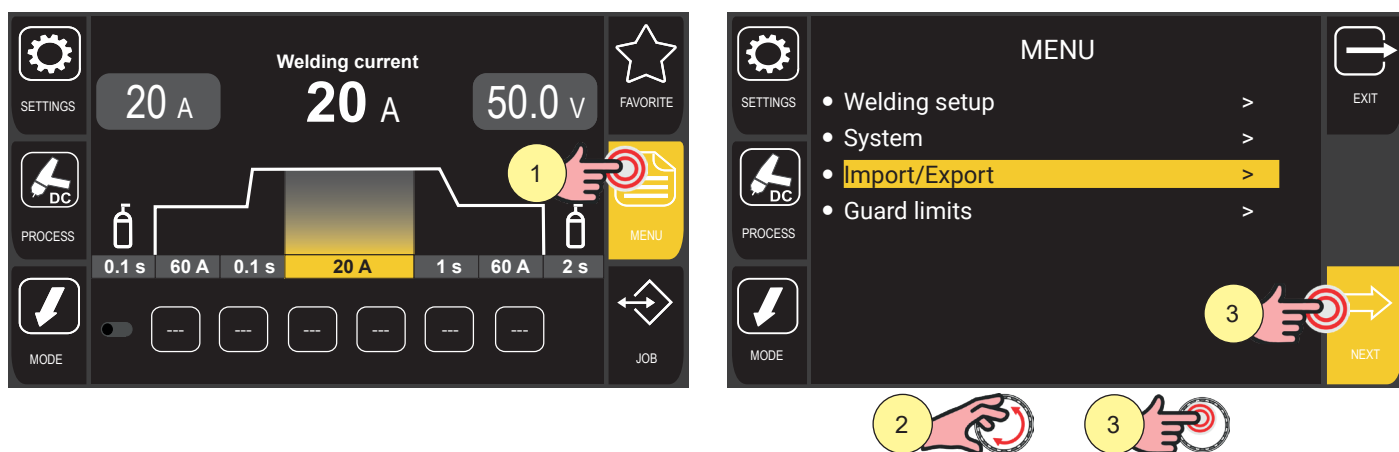

1. Press the [MENU] key.
2. Turn the encoder to select the desired setting.
Select the following path: Import/Export>
3. Press the encoder key or the [NEXT] key to confirm.

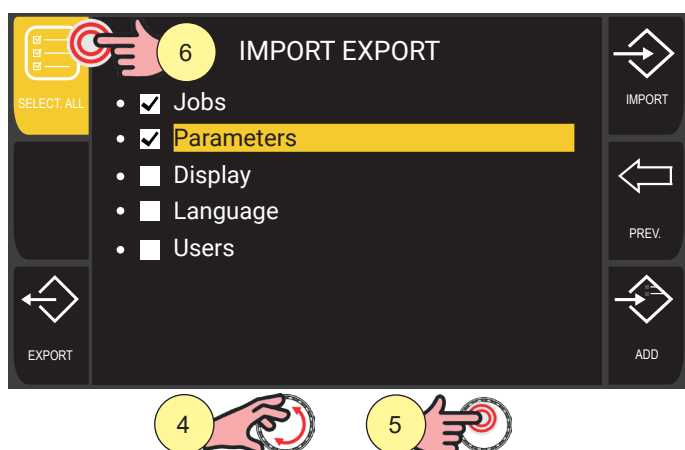

4. Rotate the encoder to select the desired parameters.
5. Press the [ENCODER] key to confirm.
6. To select/deselect all the boxes, press the [SELECT ALL] / [DESELECT ALL] key.

ENGLISH

3.5.1 Export

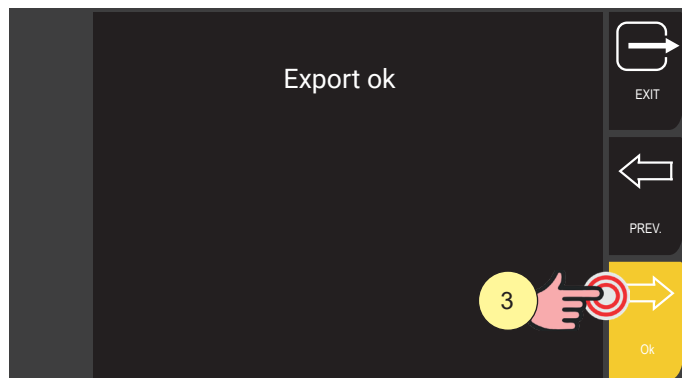

1. Please insert the USB pen drive into the dedicated port.
2. Press the [EXPORT] key to export the files to the USB pen drive.
If the export is successful, the "Export OK" message will appear.
3. Press the [Ok] key.

Press the [PREV.] key to go back to the previous screen.
Press the [EXIT] key to go back to the main screen.

3.5.2 Import

Use the [IMPORT] key to import files and JOBS previously saved on a USB pen drive.
If the JOB files on the USB flash drive occupy the same location (number before the name) as those in the device, the latter will be overwritten by those on the flash drive.

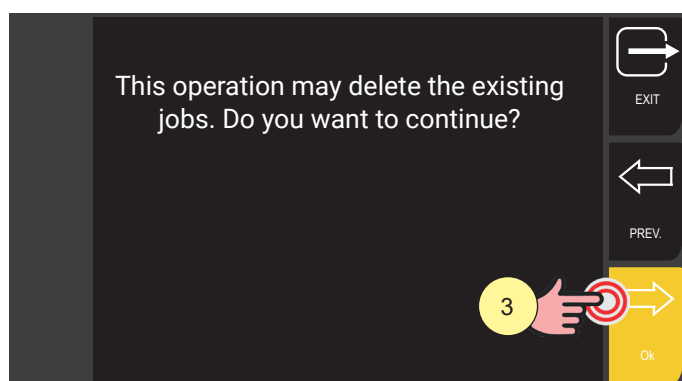

1. Please insert the USB pen drive into the dedicated port.
2. Press the [IMPORT] key to export files to the USB pen drive.
If the export is successful, the "Export OK" message will appear.
3. Press the [Ok] key.

Press the [PREV.] key to go back to the previous screen.
Press the [EXIT] key to go back to the main screen.

3.5.3 Adding jobs

Use the [ADD] key to add the files in the USB pen drive to the JOBS in the equipment. The files in the USB pen drive will be added to those in the equipment, renumbering them and placing them at the bottom of the list.

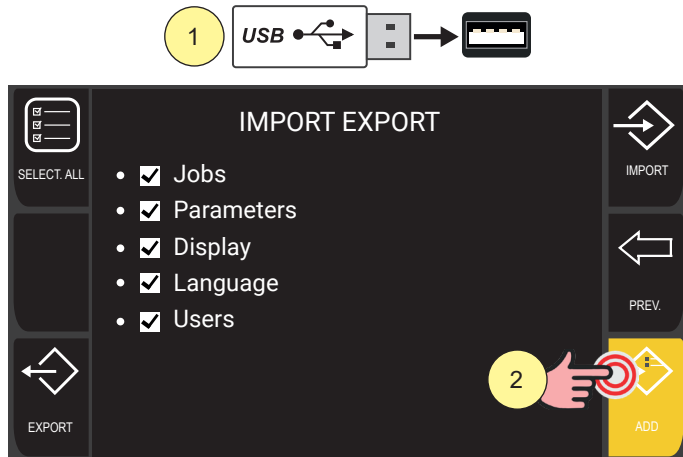

1. Please insert the USB pen drive into the dedicated port.
2. Press the [ADD] key to import the files from the USB pen drive.

Press the [PREV.] key to go back to the previous screen.

ENGLISH

3.6 SETTING GUARD LIMITS

For some parameters, it is possible to set guard limits, beyond which the generator:

- displays a "WARNING" and continues welding operations;
- displays an "ALARM" and stops the welding operations.

The warnings can be reset directly from the warning screen by pressing the [OK] key.

A message showing the type of limit exceeded is displayed on the screen. The exceeding of these limits is displayed on the log screen.

3.6.1 Guard limits activation

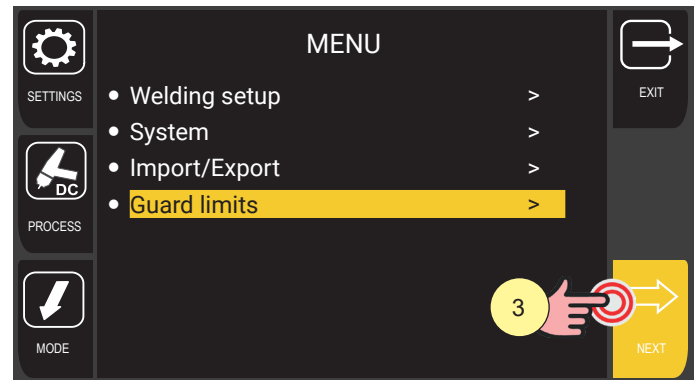
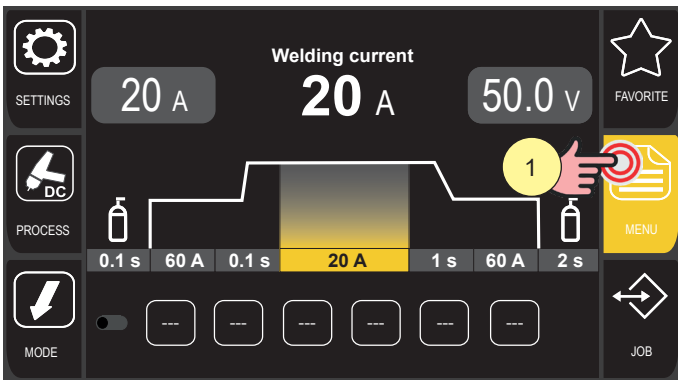

1. Press the [MENU] key.
2. Turn the encoder to select the desired setting.
Select the following path: Guard limits>
3. Press the encoder key or the [NEXT] key to confirm.

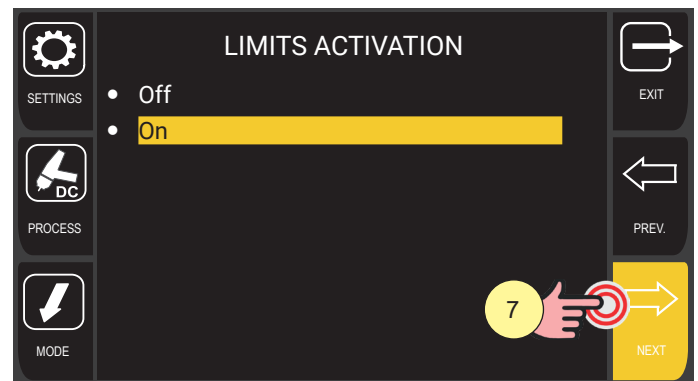
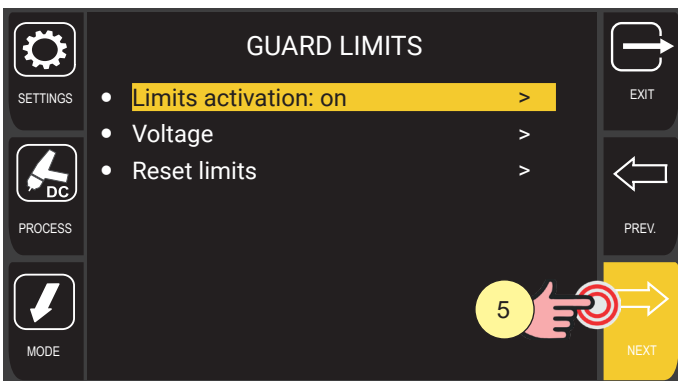

4. Turn the encoder to select the desired setting.
Select the following path: Limits activation>
5. Press the encoder key or the [NEXT] key to confirm.
6. Turn the encoder to select the desired setting.
Select the following path: On
7. Press the encoder key or the [NEXT] key to confirm.

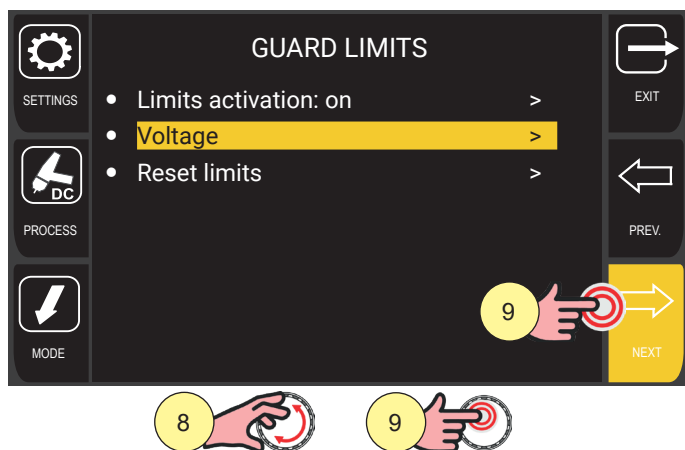

8. Turn the encoder to select the parameter to be activated.
(GUARD LIMITS: Voltage)
9. Press the encoder key or the [NEXT] key to confirm.

The adjustable thresholds for each parameter are:

- Warning Up: upper warning threshold (a warning appears on the display)
- Warning Down: lower warning threshold (a warning appears on the display)
- Alarm Up: upper alarm threshold (welding is blocked)
- Alarm Down: lower alarm threshold (welding is blocked)

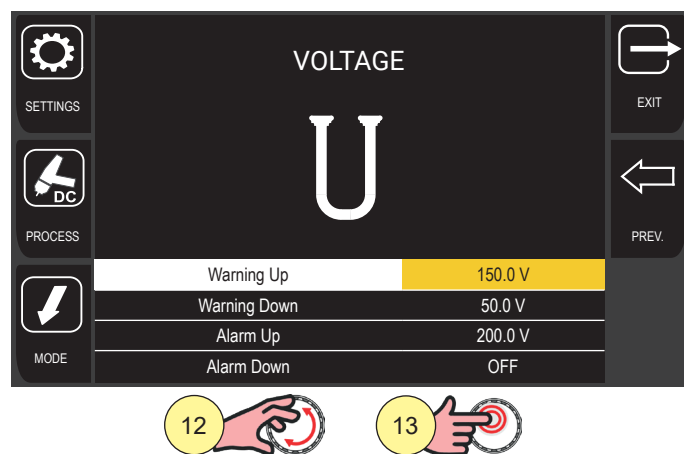
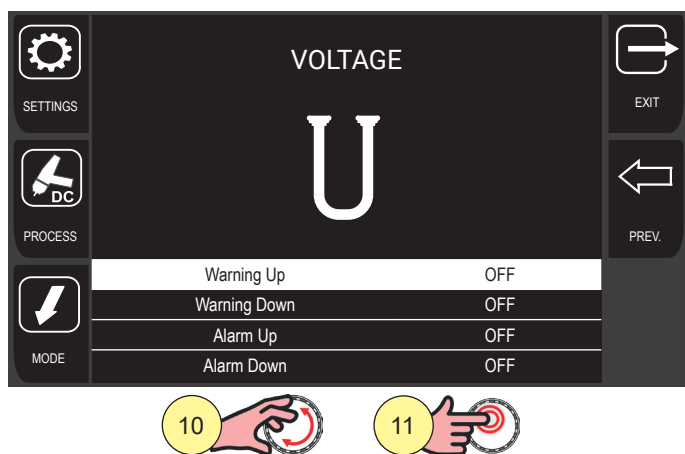

10. Rotate the encoder to select the type of threshold to be set.
11. Press the encoder key or the [NEXT] key to confirm.
12. Turn the encoder to set the desired value.
When the threshold is set to 0, the parameter is not active.
13. Press the encoder key to confirm.

Press the [PREV.] key to go back to the previous screen.

Press the [EXIT] key to go back to the main screen.

ENGLISH

3.6.2 Guard limits reset

This function sets the threshold of all guard limit values to 0.
The status of the "Limits activation" parameter is not reset.



1. Turn the encoder to select the desired setting.
Select the following path: Reset limits>
2. Press the encoder key or the [NEXT] key to confirm.
3. Press the [YES] key to confirm
4. Press the [NO] key to not confirm and exit the screen.

4 TIG DC WELDING

4.1 TIG DC PROCESS SELECTION

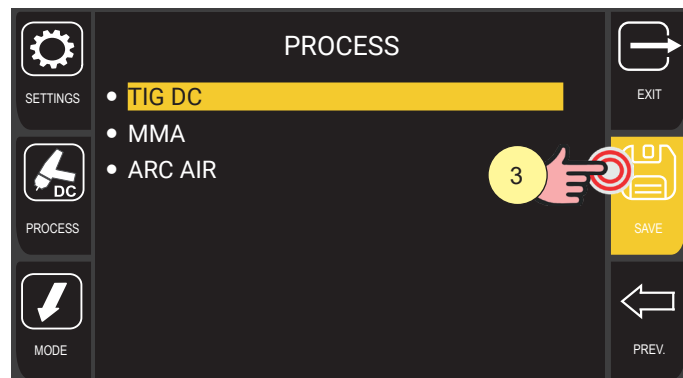
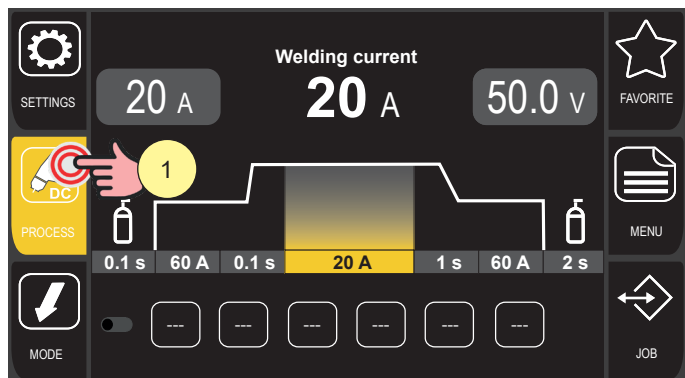

1. Press the [PROCESS] key.
2. Turn the encoder to select the desired setting.
Select the following path: TIG DC
3. Press the [ENCODER] key or the [SAVE] key to confirm.

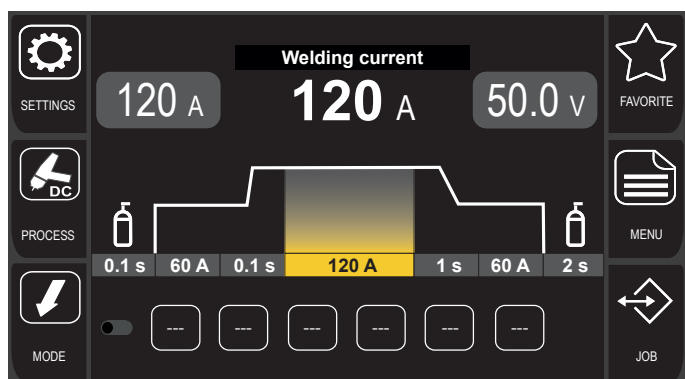

The icon appears in the process key .

ENGLISH

4.2 PROCESS PARAMETERS SETTING

The [MENU]  key is used to access the screen through which the main welding characteristics are set.

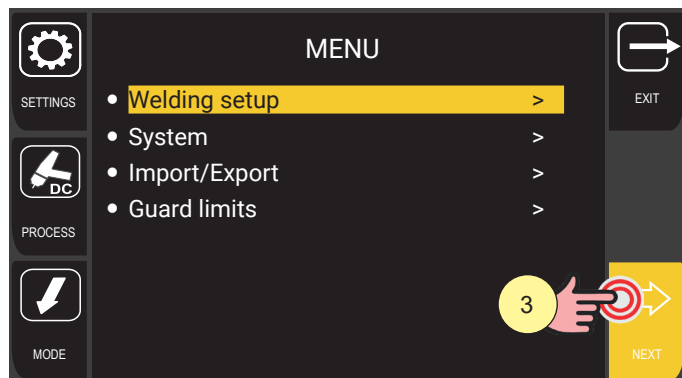
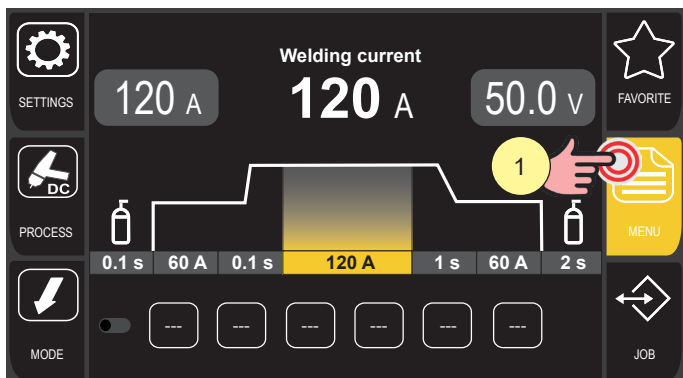

1. Press the [MENU] key.
2. Turn the encoder to select the desired setting.
Select the following path: Welding setup>
3. Press the [ENCODER] key or the [NEXT] key.

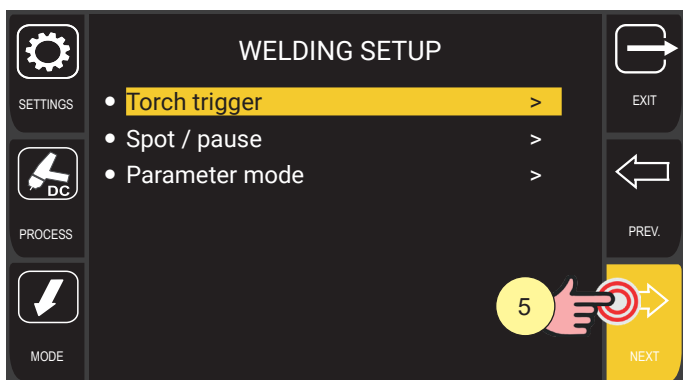

4. Turn the encoder to select the parameter to be modified.
The parameters available are: TORCH TRIGGER, SPOT/PAUSE, PARAMETER MODE
5. Press the [ENCODER] or [NEXT] button to confirm and enter the settings screen.

Press the [EXIT] key to go back to the main screen.

4.2.1 Torch trigger

This menu is used to set the function activated when the user presses the torch trigger during the welding process.

1. Press the encoder key to activate parameter change.
The parameter background is highlighted.
2. Turn the encoder to set the desired value.
3. Press the encoder key to confirm the setting.
The setting takes effect and the parameter background is no longer highlighted.

Press the [PREV.] key to go back to the previous screen.

Press the [EXIT] key to go back to the main screen.

The adjustable parameters are explained in the following paragraphs.

NO FUNCTION (OFF)

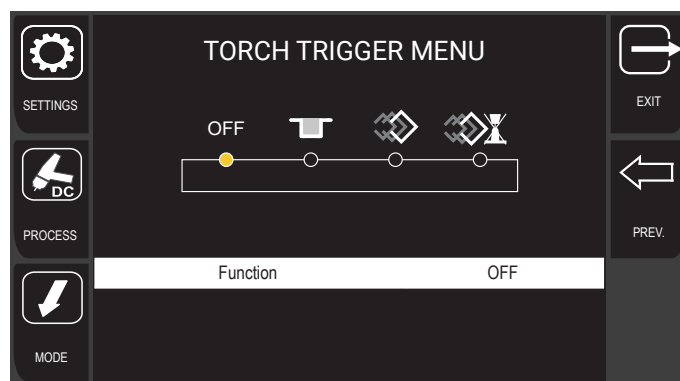

When the FUNCTION parameter is set to OFF, no function is associated with the torch trigger.

SECONDARY CURRENT (B-LEVEL)

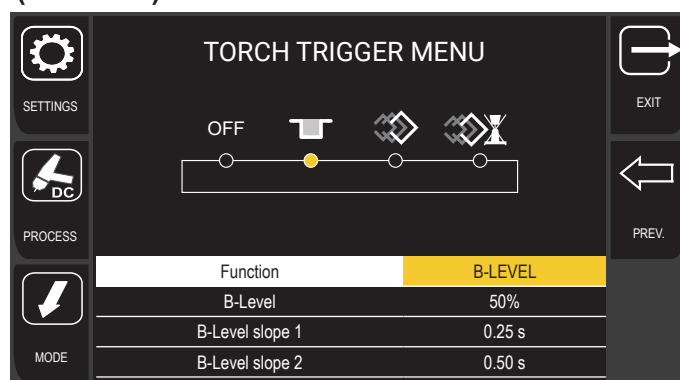

The parameter enables a special torch trigger function.

- By quickly pressing and releasing the torch trigger while welding (in 2nd stroke) a switch takes place from the main current to the set secondary current.
- Pressing and releasing the torch trigger again switches from the secondary current to the main current.
- This switching can be performed repeatedly at the discretion of the operator.
- To end the welding cycle (3rd stroke), press and hold the torch trigger. Releasing the button ends the welding cycle (4th stroke).



NOTICE! The B-LEVEL function can only be used in the 4-stroke welding mode.

ENGLISH

When the B-LEVEL function is activated, the following parameters appear and can be set by the user.

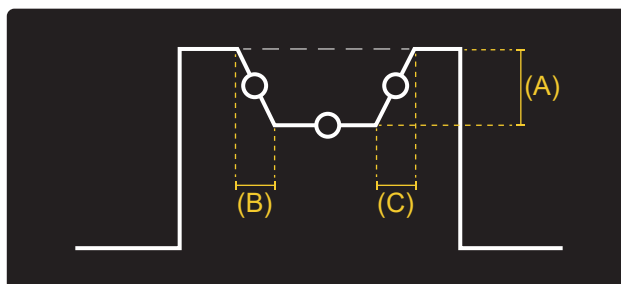

- B-LEVEL (see A in the figure): specifies the intensity of the secondary B-Level current relative to the main welding current.
Adjustment range: minimum (5%) - default (50%) - maximum (200%)
- B-LEVEL SLOPE 1 (see B in the figure): specifies the time interval in which the current intensity switches from the main current to the secondary B-Level current.
Adjustment range: minimum (OFF) - default (OFF) - maximum (3 s)
- B-LEVEL SLOPE 2 (see C in the figure): specifies the time interval in which the current intensity switches from the secondary B-Level current to the main current.
Adjustment range: minimum (OFF) - default (OFF) - maximum (3 s)

When the function is activated, the icon  appears on the display.

JOB SELECTION

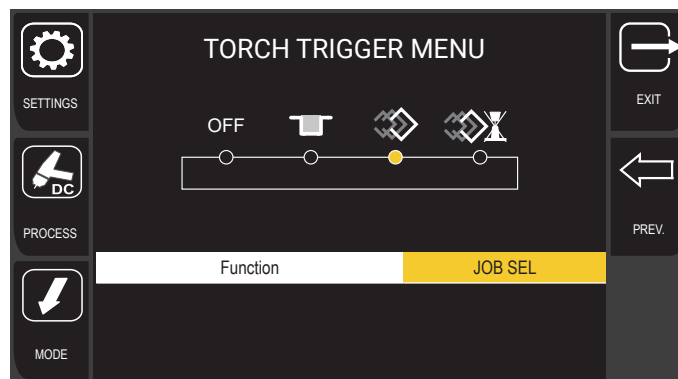

When this function is activated, pressing the torch trigger selects and loads one of the jobs previously saved by the user.

Job selection can be performed either with the arc on (during welding) or with the arc off.

Pressing and releasing the torch trigger selects the jobs in the order in which they were saved by the user. If the selected job refers to a welding process other than the one currently in progress (for example, an MMA welding job is selected while TIG DC welding is in progress), the system shows an error.

To take full advantage of this feature, it's helpful to save jobs by creating sequences.

A job sequence is created, leaving a free memory location before and after the group of JOBS belonging to the sequence.

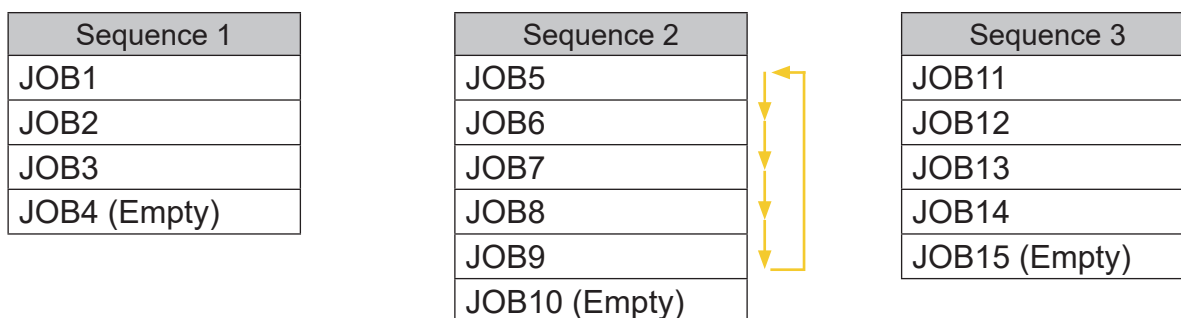

To use this feature, select and load one of the jobs belonging to the desired sequence (for example, JOB5). Using the torch trigger, it is now possible to scroll through the JOBS of sequence 2 (JOB5, JOB6, JOB7, JOB8, JOB9).

Having reached the last JOB of the sequence (JOB9), the selection will resume from the first JOB (JOB5). The same procedure can be used for sequence 1 and sequence 3, first selecting one of the jobs belonging to the two sequences.

When the function is activated, the icon  appears on the display.

JOB SELECTION (WITH ARC OFF)

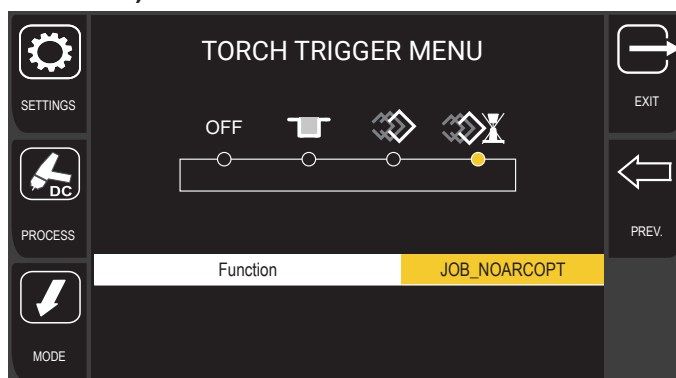

When this function is activated, pressing the torch trigger selects and loads one of the jobs previously saved by the user, according to the methods described in the JOB SELECTION section. However, job selection and loading can only be performed when the arc is off.

When the function is activated, the icon  appears on the display.

ENGLISH

4.2.2 Spot / pause

This menu is used to activate the SPOT/PAUSE function and to set the related parameters.

When the function is active, pressing the torch trigger limits the welding arc time to the time set by the user. To resume welding, press the torch trigger again.

The welding process cannot be interrupted once it has been started.

When the torch trigger is pressed, if the arc does not ignite within 10 seconds, the process is deactivated.

The welding parameters can be modified during the welding process.

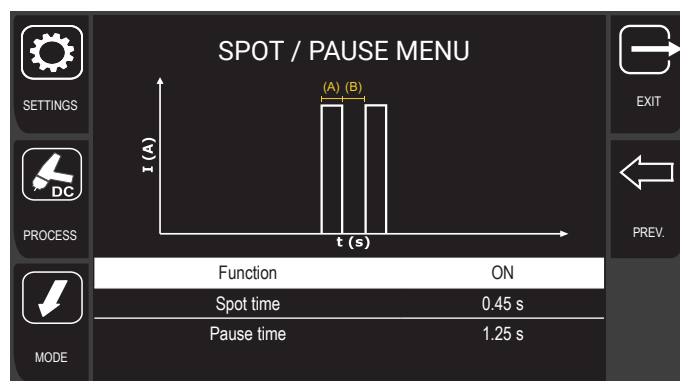

1. Turn the encoder to select the parameter to be modified.
2. Press the encoder key to activate parameter change.
The parameter background is highlighted.
3. Turn the encoder to set the desired value.
4. Press the encoder key to confirm the setting.
The setting takes effect and the parameter background is no longer highlighted.

Press the [PREV.] key to go back to the previous screen.

Press the [EXIT] key to go back to the main screen.

The parameters that can be set are the following.

FUNCTION

Enables or disables the SPOT/PAUSE function.

Adjustment range: value 1 (On) - value 2 (Off) - default (Off)

SPOT TIME

The parameter sets the spot pulse time (see A in the figure).

Adjustment range: minimum (0.0 s) - default (0.0 s) - maximum (125.0 s)

PAUSE TIME

The parameter sets the pause time after the spot pulse (see B in the figure).

Adjustment range: minimum (0.0 s) - default (0.0 s) - maximum (125.0 s)

When the function is activated, the icon  appears on the display.

4.2.3 Parameter mode

This menu is used to set whether the parameters (starting current, final current, B-Level current, and base current) should be displayed as an absolute value (ABS) or as a percentage (%) of the welding current.

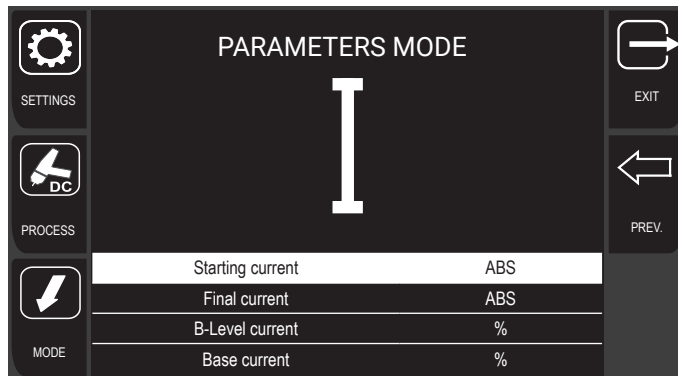

1. Turn the encoder to select the parameter to be modified.
2. Press the encoder key to activate parameter change.
The parameter background is highlighted.
3. Turn the encoder to set the desired value.
4. Press the encoder key to confirm the setting.
The setting takes effect and the parameter background is no longer highlighted.



Press the [PREV.] key to go back to the previous screen.

Press the [EXIT] key to go back to the main screen.

ENGLISH

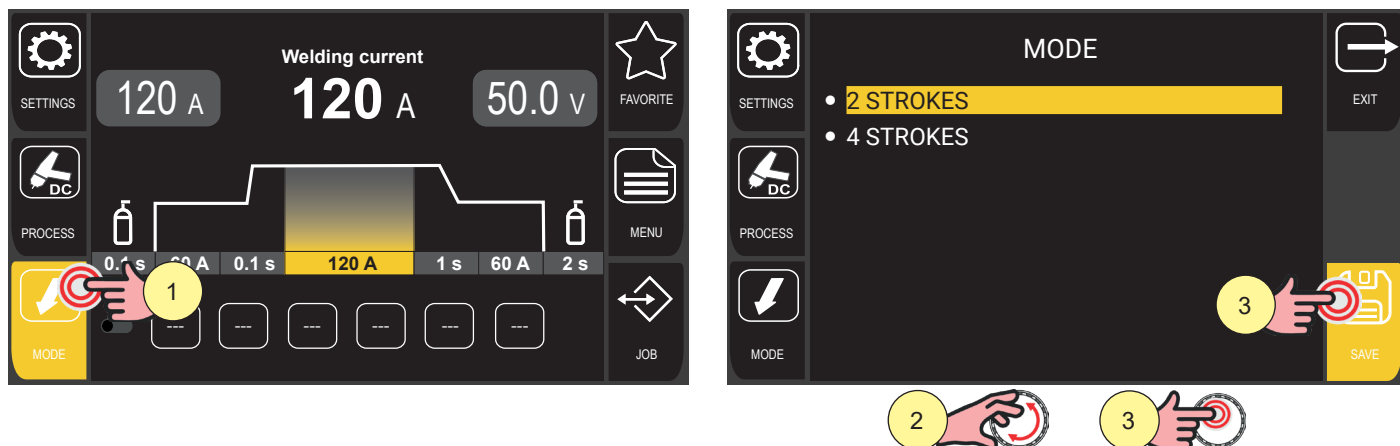
4.3 TORCH TRIGGER MODE SETTING



1. Press the [MODE] key.
2. Within the menu screen, it is possible to select the torch trigger mode.
 -  2 STROKES
 -  4 STROKES
3. Turn the encoder to select the desired setting.
4. Press the encoder key or the [SAVE] key to confirm.

The following paragraphs explain the different welding procedures depending on whether the torch trigger is set to 2 strokes or 4 strokes mode.

The welding procedures differ further if the arc is ignited in lift mode or high frequency (HF) mode and the B-LEVEL function is activated.

4.3.1 2 strokes mode with lift ignition

- Touch the workpiece with the torch electrode.
- Press (1T) and keep the torch trigger pressed.
- Slowly raise the torch to ignite the arc with the starting current.
- The welding current reaches the set value in a time equal to the up slope.
- Release (2T) the trigger to start the weld completion procedure.
- The current reaches the set final value in a time equal to the down slope time.
- The arc is extinguished.
- Gas flow continues for a time equal to the post-gas period.

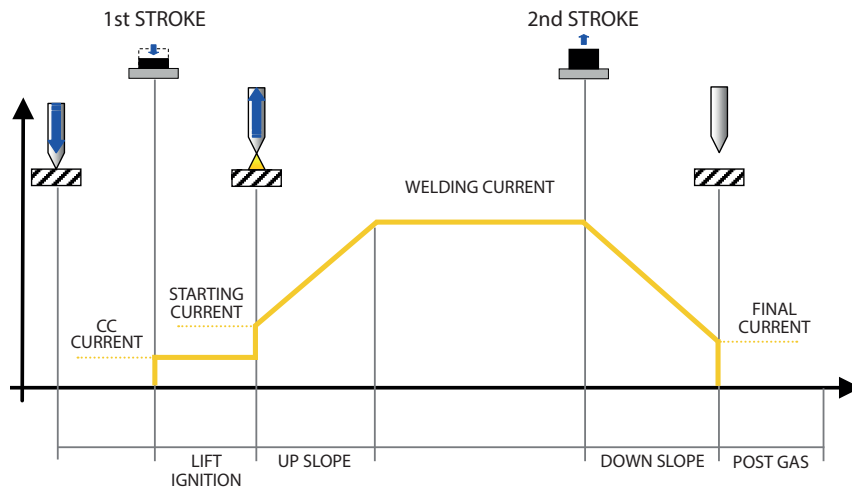

4.3.2 2 strokes mode with HF ignition

- Move the torch close to the workpiece, keeping the electrode tip 2-3 mm away from the workpiece.
- Press (1T) and keep the torch trigger pressed.
- The arc is ignited without contact with the workpiece and the voltage discharges (HF) stop automatically.
- The welding current reaches the set value in a time equal to the up slope.
- Release (2T) the trigger to start the weld completion procedure.
- The current reaches the set final value in a time equal to the down slope time.
- The arc is extinguished.
- Gas flow continues for a time equal to the post-gas period.

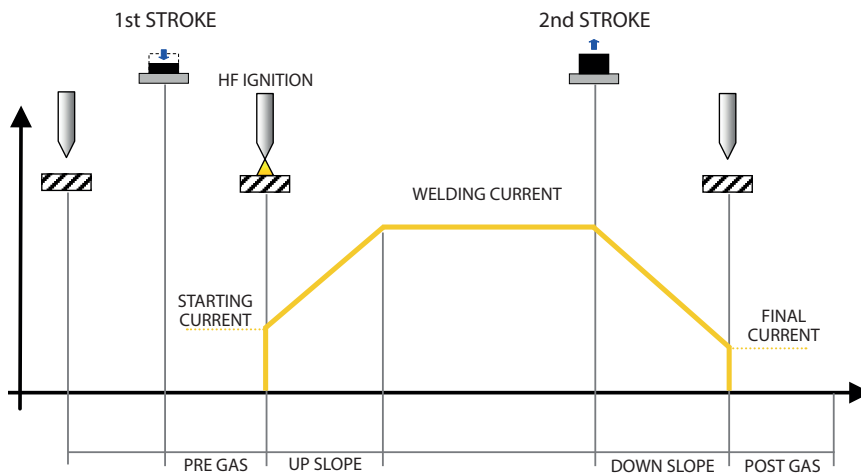

ENGLISH

4.3.3 4 strokes mode with lift ignition

- Touch the workpiece with the torch electrode.
- Press (1T) and keep the torch trigger pressed.
- Slowly raise the torch to ignite the arc.
- The arc ignites, and the welding current returns to the starting current value.
- Release (2T) the torch trigger.
- The welding current reaches the set value in a time equal to the up slope.
- Press (3T) trigger and keep it pressed to start the weld completion procedure.
- The current reaches the set final value in a time equal to the down slope time.
- The electric arc remains on and a current equal to the final current is delivered. In these conditions it is possible to close the weld pool (crater filler current).
- Release (4T) the trigger to stop the arc.
- Gas flow continues for a time equal to the post-gas period.

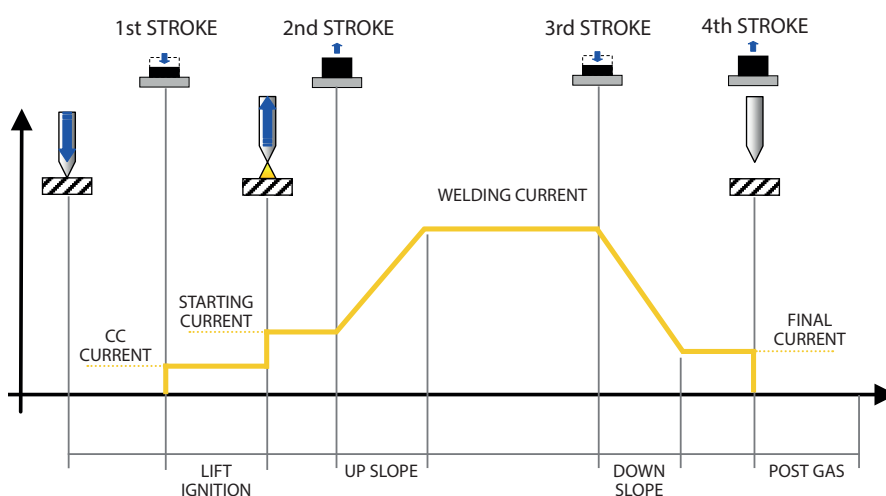

4.3.4 4 strokes mode with HF ignition

- Move the torch close to the workpiece, keeping the electrode tip 2-3 mm away from the workpiece.
- Press (1T) and keep the torch trigger pressed.
- The arc is ignited without contact with the workpiece and the voltage discharges (HF) stop automatically.
- The welding current returns to the starting current value.
- Release (2T) the torch trigger.
- The welding current reaches the set value in a time equal to the up slope.
- Press (3T) trigger and keep it pressed to start the weld completion procedure.
- The current reaches the set final value in a time equal to the down slope time.
- The electric arc remains on and a current equal to the final current is delivered.
In these conditions it is possible to close the weld pool (crater filler current).
- Release (4T) the trigger to stop the arc.
- Gas flow continues for a time equal to the post-gas period.

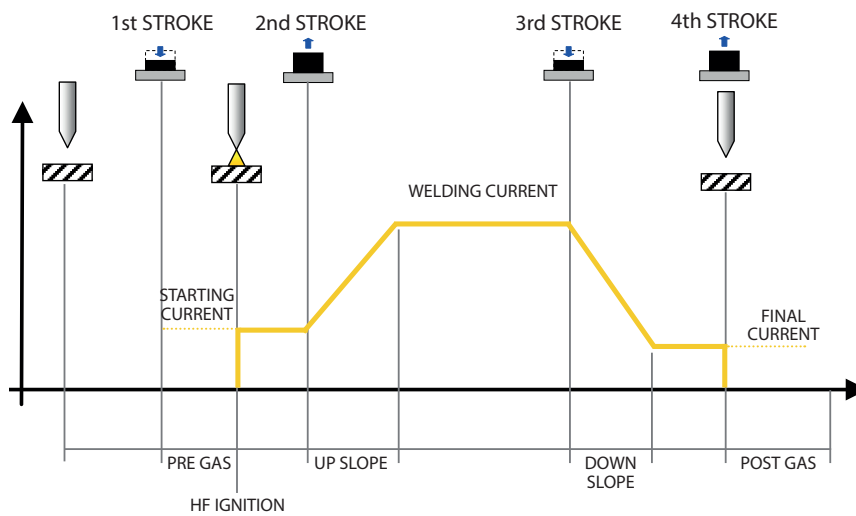

ENGLISH

4.3.5 4 strokes B-Level mode with lift ignition

- Touch the workpiece with the torch electrode.
- Press (1T) and keep the torch trigger pressed.
- Slowly raise the torch to ignite the arc.
- The welding current returns to the starting current value.
- Release (2T) the torch trigger.
- The welding current reaches the set value in a time equal to the up slope.
- Press and immediately release the torch trigger to switch to the second welding current.
- The trigger must not be held down for more than 0.3 seconds, otherwise the welding completion phase will begin.
- Press and immediately release the torch trigger to return to the main welding current.
- Press (3T) trigger and keep it pressed to start the weld completion procedure.
- The current reaches the set final value in a time equal to the down slope time.
- The electric arc remains on and a current equal to the final current is delivered.
In these conditions it is possible to close the weld pool (crater filler current).
- Release (4T) the trigger to stop the arc.
- Gas flow continues for a time equal to the post-gas period.

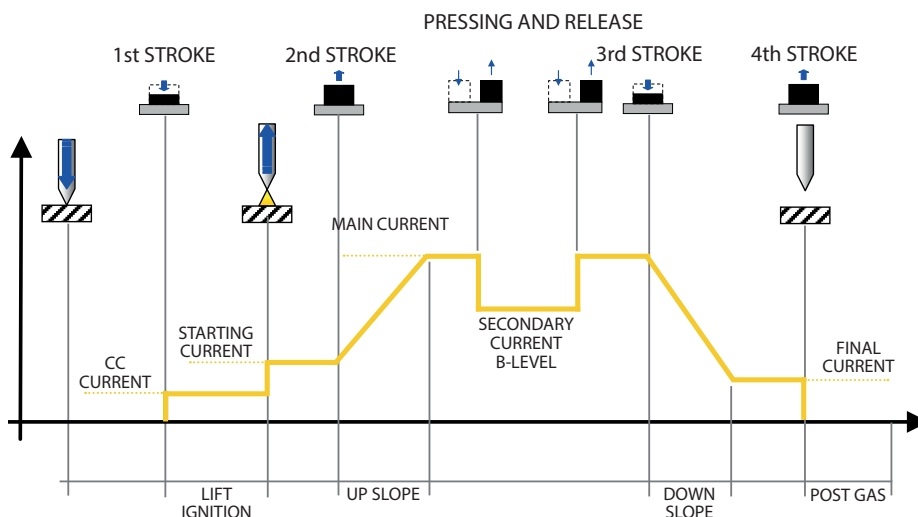

4.3.6 4 strokes B-Level mode with HF ignition

- Move the torch close to the workpiece, keeping the electrode tip 2-3 mm away from the workpiece.
- Press (1T) and keep the torch trigger pressed.
- The arc is ignited without contact with the workpiece and the voltage discharges (HF) stop automatically.
- The welding current returns to the starting current value.
- Release (2T) the torch trigger.
- The arc is ignited without contact with the workpiece and the voltage discharges (HF) stop automatically.
- The welding current reaches the set value in a time equal to the up slope.
- Press and immediately release the torch trigger to switch to the second welding current.
- The trigger must not be held down for more than 0.3 seconds, otherwise the welding completion phase will begin.
- Press and immediately release the torch trigger to return to the main welding current.
- Press (3T) trigger and keep it pressed to start the weld completion procedure.
- The current reaches the set final value in a time equal to the down slope time.
- The electric arc remains on and a current equal to the final current is delivered.
In these conditions it is possible to close the weld pool (crater filler current).
- Release (4T) the trigger to stop the arc.
- Gas flow continues for a time equal to the post-gas period.

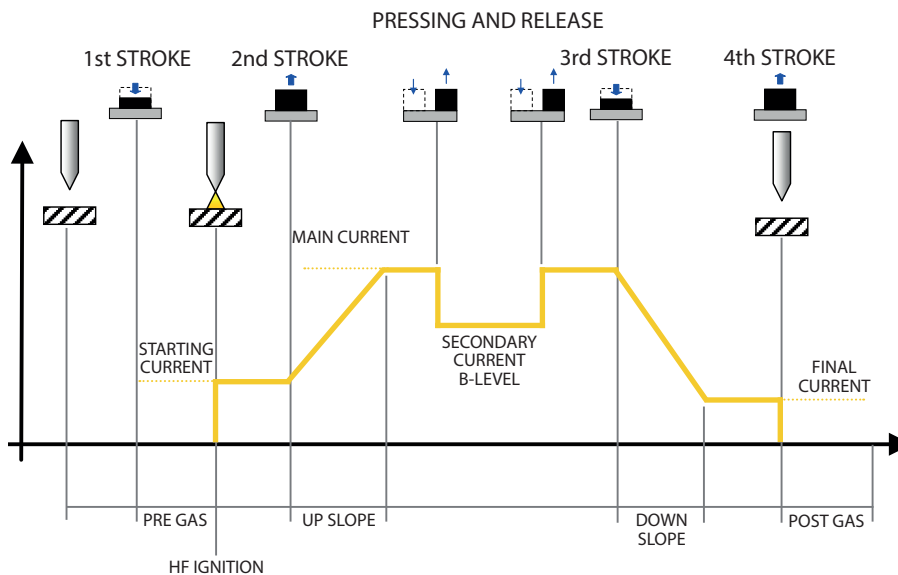

ENGLISH

4.4 WELDING SETTINGS

The [SETTINGS] key allows access to the menu through which the main characteristics of the weld are set.

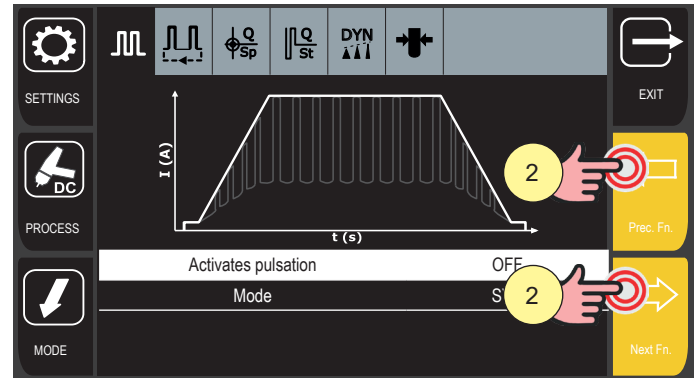
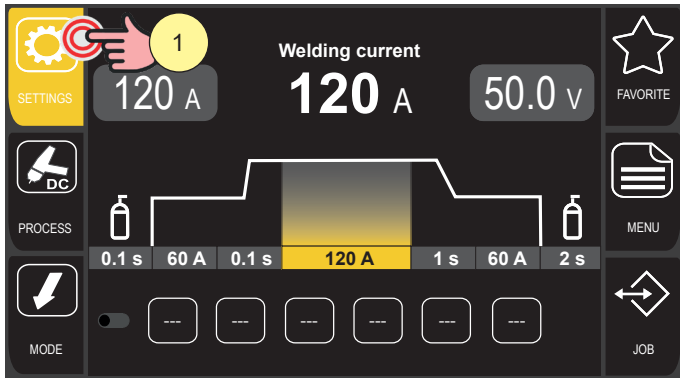

1. Press the [SETTINGS] key.
2. Press the [PREV FN] or [NEXT FN] keys to scroll through the available screens.
 - Pulsed
 - Multiple pulsed
 - Q-Spot
 - Q-Start
 - Dynamic arc
 - Diameter

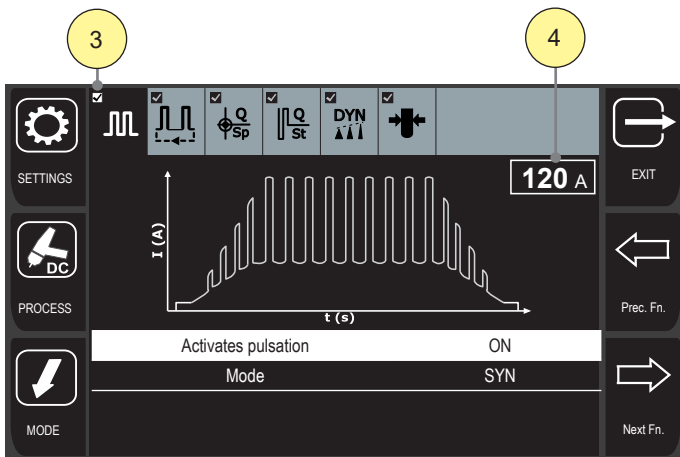

3. When a function is activated, a check mark appears in the top bar next to its icon. This allows the user to immediately see which functions are active, without having to scroll through the menu screens.
4. In the function activation screens, the right-hand box displays the welding current setting, making it easier for the user to make adjustments.

Press the [EXIT] key to go back to the main screen.

4.4.1 Pulsed

This menu is used to activate the PULSED function and to set its parameters.

In pulsed mode, the welding current is not constant, but varies cyclically between a higher peak (corresponding to the main current) and a lower peak (corresponding to the base current).

This feature reduces the heat input to the workpiece and facilitates joining of the two edges.

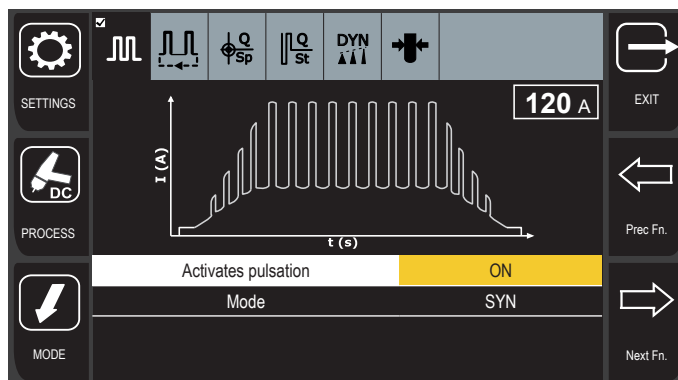

1. Turn the encoder to select the parameter to be modified.
 2. Press the encoder key to activate parameter change.
The parameter background is highlighted.
 3. Turn the encoder to set the desired value.
 4. Press the encoder key to confirm the setting.
The setting takes effect and the parameter background is no longer highlighted.
- Press the [EXIT] key to go back to the main screen.

Two different pulse modes can be selected:

SYNERGIC

This mode allows the operator to set only the welding current, while the other parameters are automatically adjusted by the machine. Synergic mode is optimised for fillet welding.

This process produces a highly concentrated arc. It is a very stable arc and moves the weld pool with strong oscillations. It is perfectly suited to tack welding and the creation of thin weld seams. It is recommended for thin layers, and especially where a very stable arc is required (viscous weld pools).

When the function is activated, the icon  appears on the display.

MANUAL

In this mode the user can manually set the pulse parameters.

When the function is activated, the icon  appears on the display.

ENGLISH

The following describes the pulsed parameters that can be set manually.

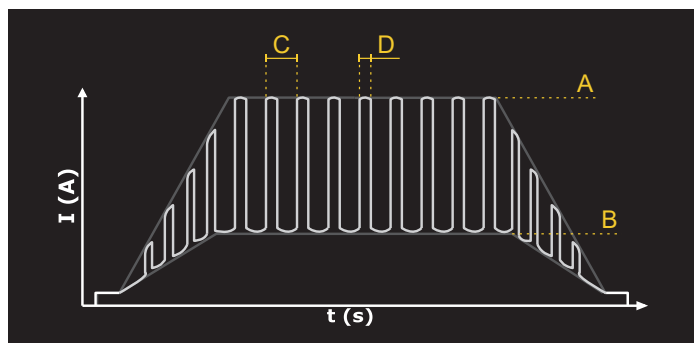

KEY:

- (A) Main current
- (B) Base current
- (C) Time interval between two pulses (frequency = $1/T$)
- (D) Duty

PULSE FREQUENCY

Defines the double speed freq.

The higher the frequency, the tighter the bead will be and the longer the welding time. As the frequency increases, the heat-affected zone will narrow.

The pulsed arc with high frequencies (from 1 kHz) is suitable for flat welds (butt or over-butt) for thicknesses less than 1 mm.

Consequences of a higher value:

- Lower melting rate.
- Reduction of the heat-affected zone.

Regulation range: minimum (0.1 Hz) - default (2.0 Hz) - maximum (5.0 Hz)

DOUBLE SPEED DUTY

The parameter adjusts the current peak time as a percentage of the pulse period.

Adjustment range: minimum (1%) - default (30%) - maximum (90%)

BASE CURRENT

Defines the minimum pulsed current as a percentage of the main current.

Consequences of a higher value:

- Faster weld pool creation.
- Increased heat-affected zone.

Adjustment range: minimum (1%) - default (50%) - maximum (80%)

WAVEFORM

The waveform of the upper and lower peaks can be defined separately, with the following options.

SQUARE WAVE

- Advantages:
 - High energy transmitted to the workpiece.
 - Very bright and clean weld bead appearance.
 - High welding speed and excellent penetration.
- Disadvantages:
 - High welding arc noise.

SINUSOIDAL WAVE

- Advantages:
 - Good energy transmitted to the workpiece.
 - Very bright and clean weld bead appearance.
 - Good welding speed and excellent penetration.
 - Low welding arc noise.
- Disadvantages:
 - Performance slightly inferior to that of the square wave.

SMOOTH SQUARE WAVE

- A special waveform that combines the characteristics of the square wave and the sinusoidal wave.

TRIANGULAR WAVE

- Advantages:
 - Low energy transmitted to the workpiece, making it suitable for materials or alloys with low melting points.
 - Penetration control (not high).
 - Very low welding arc noise.
- Disadvantages:
 - This current is not suitable for high welding speeds or when bright beads or high penetration are required.

ENGLISH

4.4.2 Multiple Pulse (MPULSE)

This menu is used to activate the multiple pulse (MPULSE) function and to set the related parameters.

Compared to standard pulsed welding, this feature introduces an additional welding current pulse at the upper and lower peaks of the main pulse, further improving control of heat input to the workpiece and the joining of the two edges.

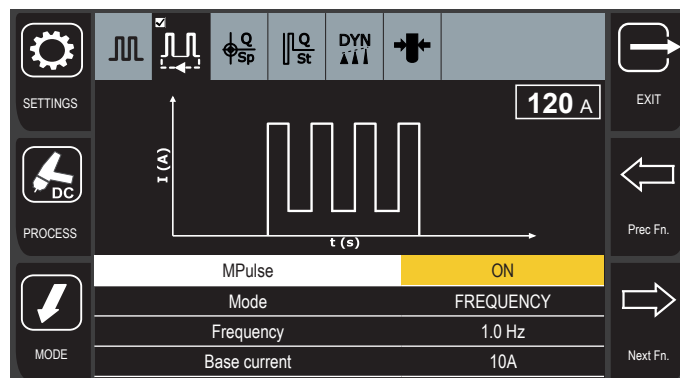

1. Turn the encoder to select the parameter to be modified.
 2. Press the encoder key to activate parameter change.
The parameter background is highlighted.
 3. Turn the encoder to set the desired value.
 4. Press the encoder key to confirm the setting.
The setting takes effect and the parameter background is no longer highlighted.
- Press the [EXIT] key to go back to the main screen.

It is possible to change the following MPULSE function settings:

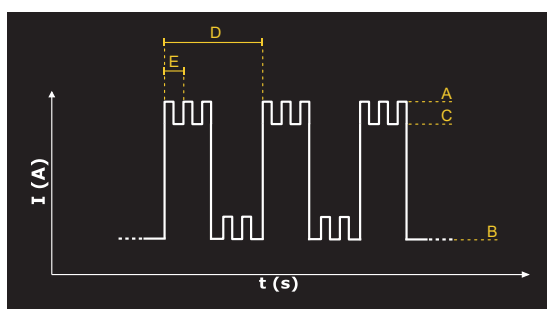

- KEY:
- (A) Main current
 - (B) Main pulsed base current
 - (C) Multiple pulsed base current
 - (D) Main pulsed frequency
 - (E) Multiple pulsed frequency

MPULSE

Used to activate or deactivate the MPULSE function.

Adjustment range: value 1 (ON) - value 2 (OFF) - default (OFF)

MODE

Defines whether the setting parameters are provided as double speed freq. or as the current peak time. When the FREQUENCY option is selected, the adjustable parameter is FREQUENCY. When the TIME option is selected, the adjustable parameters are MEAN CURRENT TIME and BASE CURRENT TIME.

Adjustment range: value 1 (FREQUENCY) - value 2 (TIME) - default (FREQUENCY)

FREQUENCY

Defines the frequency in Hz of the multiple pulse (only when the MODE parameter is set to FREQUENCY).

The values in the adjustment range depend on the frequency set for the main pulse.

MEAN CURRENT TIME

Defines the time in s of the main current peak (only when the MODE parameter is set to TIME).

The values in the adjustment range depend on the frequency set for the main pulse.

BASE CURRENT TIME

Defines the time in s of the base current peak (only when the MODE parameter is set to TIME).

The values in the adjustment range depend on the frequency set for the main pulse.

BASE CURRENT

Defines the base current of the multiple pulse.

The values in the adjustment range depend on the base current set for the main pulse.

PULSE ON BASE CURRENT

Used to activate or deactivate pulsation during the base current, leaving it active only during the main current.

Adjustment range: value 1 (ON) - value 2 (OFF) - default (OFF)

When the function is activated, the icon  appears on the display.

ENGLISH

4.4.3 Q-SPOT

This menu is used to activate the Q-SPOT function and to set its parameters.

This function significantly facilitates spot welding.

With the arc off, the electrode can be precisely positioned at the point to be welded. Only after the electrode is lifted does the machine emit the welding pulse for the set time.

This significantly reduces the risk of electrode contamination of the joint.

By holding down the torch trigger, it is possible to repeat the process as many times as desired.

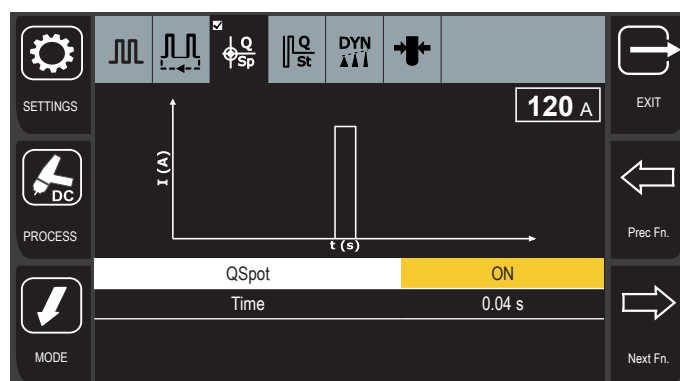

This function is perfectly suited to tacking thinner wall thicknesses, butt welding and pipe welding.



1. Turn the encoder to select the parameter to be modified.
 2. Press the encoder key to activate parameter change.
The parameter background is highlighted.
 3. Turn the encoder to set the desired value.
 4. Press the encoder key to confirm the setting.
The setting takes effect and the parameter background is no longer highlighted.
- Press the [EXIT] key to go back to the main screen.

Operating procedure:

- Position the torch with the electrode on the spot to be welded.
- Press the torch trigger and then lift the torch.
- After lifting the torch, the arc is ignited and remains lit for the set time.

-  **NOTICE!** It is advisable to set the highest possible current with the lowest possible time (0.01 - 0.5 s).
-  **NOTICE!** It is important to ensure that the up and down slopes are zero (0 s). If the spot welding time is less than 1 s, the up and down slopes are automatically eliminated from the welding process, although they remain displayed and can be set via the user interface.

When the function is activated, the icon  appears on the display.

4.4.4 Q-START

This menu is used to activate the Q-START function and to set its parameters.

The Q-START function allows synergic pulsed TIG welding to start for the set time, then automatically switches to the process selected on the panel. This creates a weld pool more quickly than with a standard start because the molten material moves between the two edges, accelerating their joining. The Q-START function is useful for tack welding thin sheet metal.

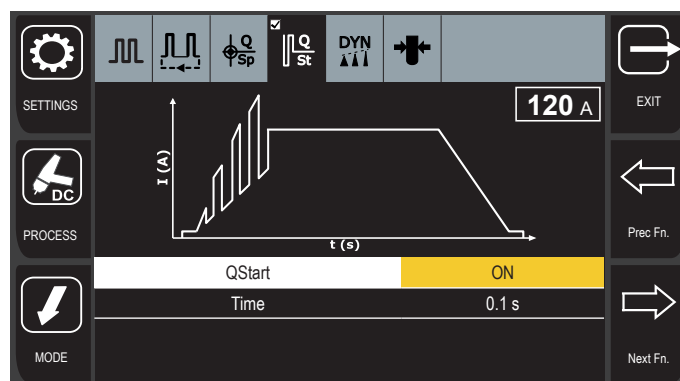

1. Turn the encoder to select the parameter to be modified.
 2. Press the encoder key to activate parameter change.
The parameter background is highlighted.
 3. Turn the encoder to set the desired value.
 4. Press the encoder key to confirm the setting.
The setting takes effect and the parameter background is no longer highlighted.
- Press the [EXIT] key to go back to the main screen.

The recommended parameters for Q-START are shown in the following table

ANGLE / BUTT-BUTT JOINT		
Sheet thickness (mm)	Current (A)	Q-Start Value (seconds)
1.0 mm	35A - 50 A	0.5 - 1.0 s
2.0 mm	50A - 80 A	
3.0 mm	80A - 140 A	
4.0 mm	140A - 170 A	

When the function is activated, the icon  appears on the display.

ENGLISH

4.4.5 Dynamic arc

This menu is used to activate the DYNAMIC ARC function and to set the related parameters.

This function allows a reduction in arc voltage to increase the welding current and vice-versa. The amount of Dynamic Arc variation can be individually adjusted from 1 A to 50 A. For example, a 1 V variation results in a 20 A increase.

For optimal control over the arc, it is recommended to ignite at a distance of approximately 4-5 mm from the initial junction point (zero point).

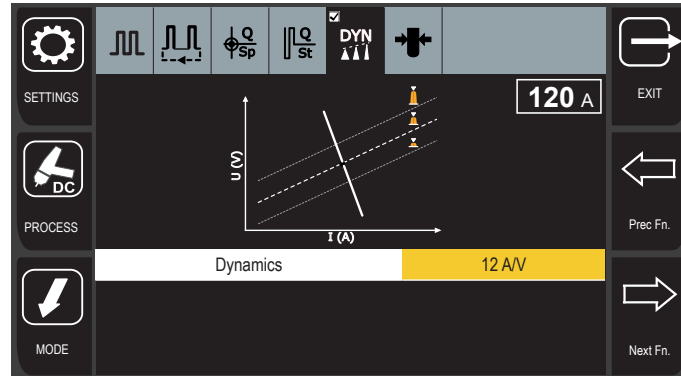

1. Press the encoder key to activate parameter change.
The parameter background is highlighted.
 2. Turn the encoder to set the desired value.
 3. Press the encoder key to confirm the setting.
The setting takes effect and the parameter background is no longer highlighted.
- Press the [EXIT] key to go back to the main screen.

The available options are

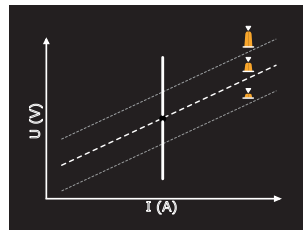

- CC (constant current):
The dynamic arc function is deactivated and the welding current remains constant at the value set by the user on the control panel.

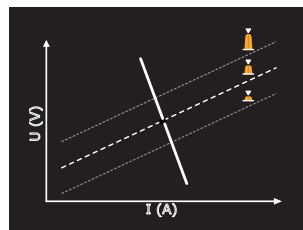

- Manual adjustment from 1 to 50 A/V:
This value must be set according to the material thickness and the type of work being performed (values between 1 A and 20 A for thin thicknesses, values between 20 A and 50 A for medium-to-large thicknesses).
This function stabilises the width of the weld bead as the torch height varies.

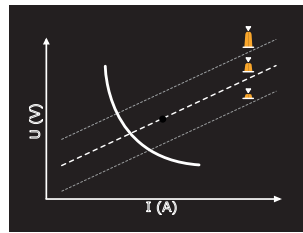

- Dyn:

The welding power is always kept constant as the distance between the electrode and the workpiece varies.

This function stabilises the heat input to the weld pool as the torch height varies.

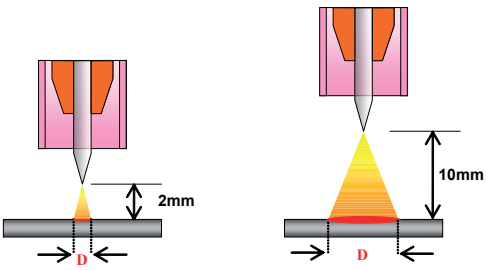
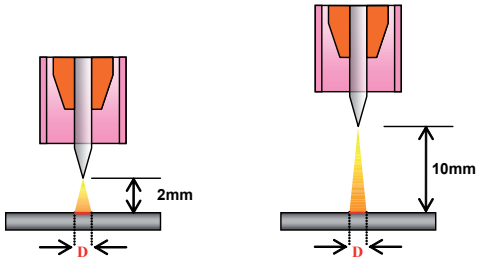
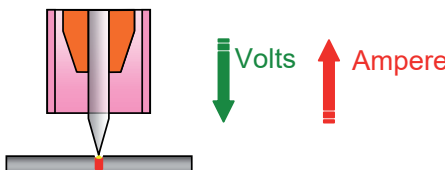
STANDARD TIG DC WELDING	TIG DC WELDING WITH DYNAMIC ARC
	
<p>As the arc length varies, the weld pool (D) widens, resulting in an increase in heat input to the workpiece, causing it to overheat.</p>	<p>As the arc length varies, the weld pool remains exactly the same size (D), preventing overheating of the workpiece, plastic deformation, and loss of mechanical properties.</p>
	

The recommended parameters for the dynamic arc are shown in the following table.

ANY TYPE OF JOINT		
Sheet thickness (mm)	Current (A)	DynArc Value (A/V)
1.0 mm	35A - 50 A	5 - 10
2.0 mm	50A - 80 A	10 - 15
3.0 mm	80A - 140 A	15 - 25
4.0 mm	140A - 170 A	25 - 50

When the function is activated, the icon  appears on the display.

ENGLISH

4.4.6 Electrode diameter

This parameter optimises the welding arc ignition based on the characteristics of the selected electrode.

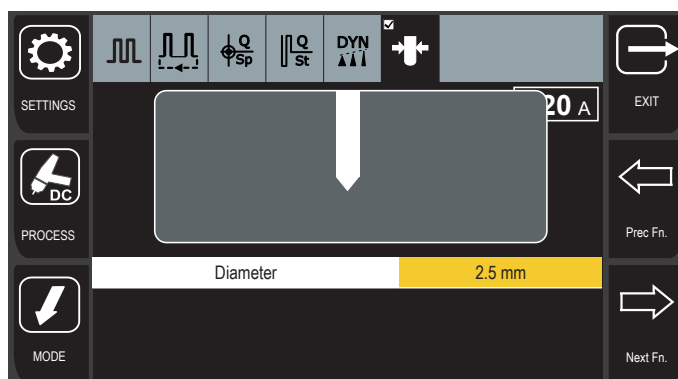

1. Press the encoder key to activate parameter change.
The parameter background is highlighted.
 2. Turn the encoder to set the desired value.
 3. Press the encoder key to confirm the setting.
The setting takes effect and the parameter background is no longer highlighted.
- Press the [EXIT] key to go back to the main screen.

i Information When a welding current that is too high for the diameter of the selected electrode is set, the icon appears on the display. 

5 MMA WELDING

5.1 MMA PROCESS SELECTION

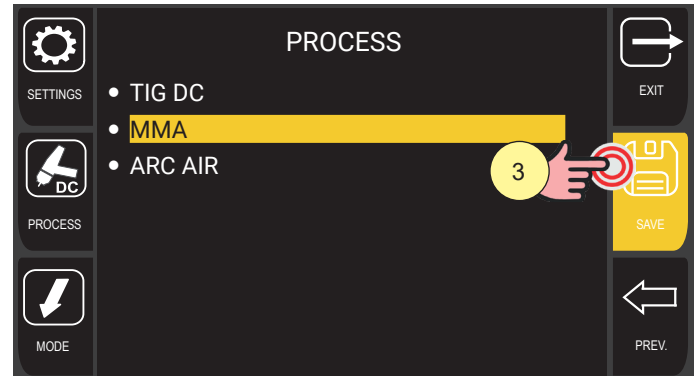
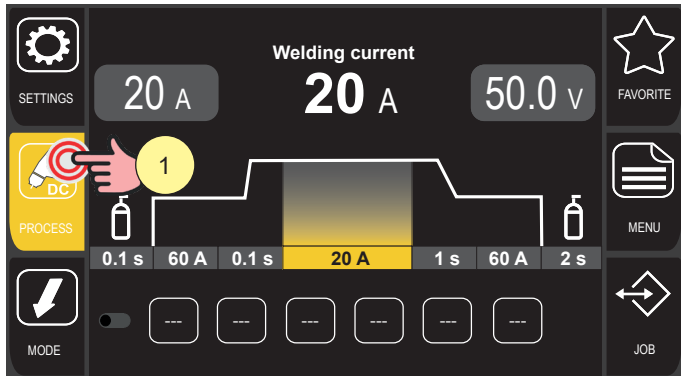

1. Press the [PROCESS] key.
2. Turn the encoder to select the desired setting.
Select the following path: MMA
3. Press the [ENCODER] key or the [SAVE] key to confirm.

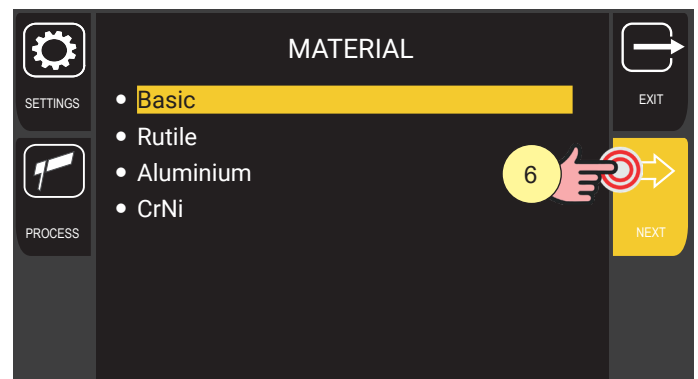
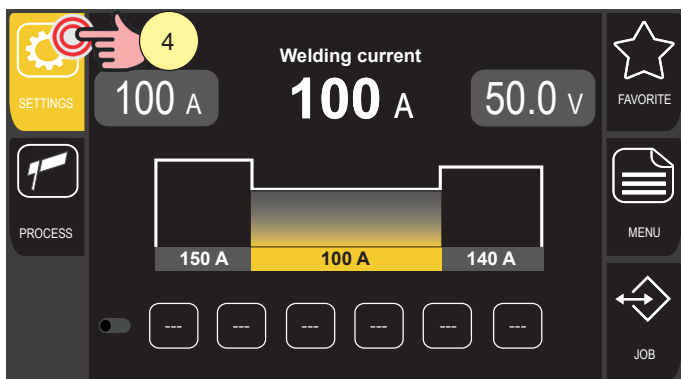

The icon appears in the process key .

4. Press the [SETTINGS] key.
5. Turn the encoder to select the desired setting.
(Basic, Rutile, Aluminium, CrNi)
6. Press the [ENCODER] key or the [NEXT] key to confirm.

Press the [EXIT] key to exit the screen.

ENGLISH

5.2 PROCESS PARAMETERS SETTING

The [MENU] key gives access to the menu by means of which the main characteristics of the weld are set.

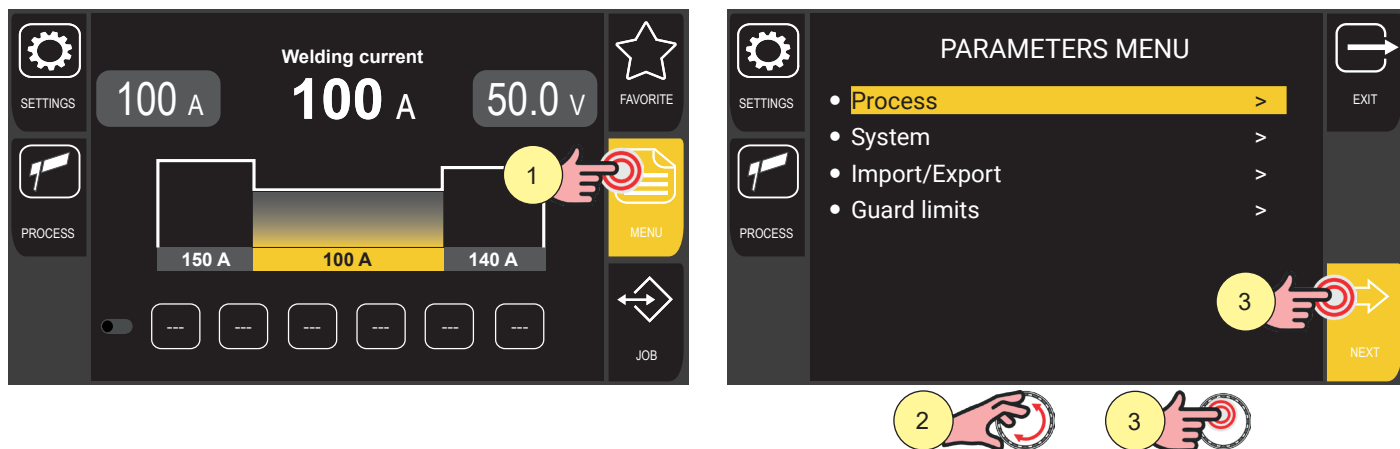

1. Press the [MENU] key.
2. Turn the encoder to select the desired setting.
Select the following path: Process>
3. Press the [ENCODER] key or the [NEXT] key.
4. Turn the encoder to select the parameter to be modified.
The parameters available are: POLARITY, VRD, VOLT END, DYNAMIC
5. Press the [ENCODER] key to confirm.
6. Turn the encoder to set the desired value.
7. Press the [ENCODER] key to confirm the setting.

Press the [EXIT] key to go back to the main screen.

5.2.1 MMA parameters (parameters menu)

VOLT END

This parameter sets the voltage value for which the weld is exited by lifting the electrode. To exit MMA welding, it is generally necessary to lift the electrode considerably; setting the parameter to a low value ends the welding operation with minimal lifting of the electrode and less spatter is generated and the workpiece remains cleaner.



NOTICE! A value that is too low may cause frequent welding interruptions.

Adjustment range: minimum (20 V) - default (45 V) - maximum (50 V)

VRD

The parameter activates or deactivates the VRD (Voltage Reduction Device) function. This function reduces the voltage between the welding sockets to a safe level when not welding.

The procedure for re-igniting the arc is as follows.

- Touch the workpiece with the tip of the electrode.
- Raise the electrode.
- The voltage is released for a few seconds.
- Touch the workpiece with the tip of the electrode.
- The welding arc is ignited.

Adjustment range: value 1 (Off) - value 2 (On) - default (Off)

ENGLISH

DYNAMICS

With low values, this parameter allows for a softer arc with less spatter or, with high values, it allows for a harder and more stable arc.

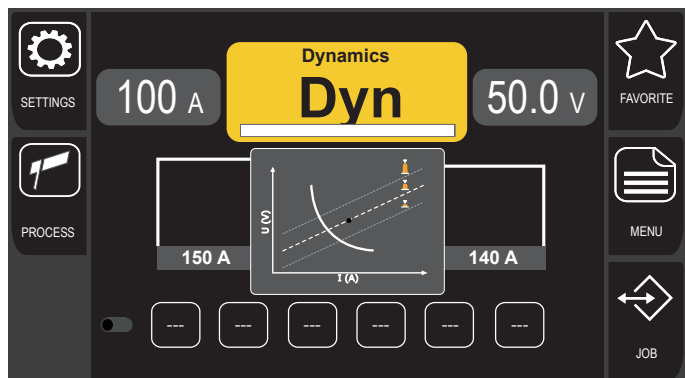
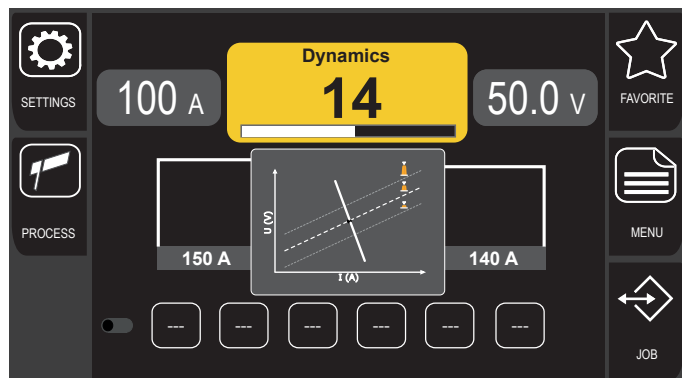
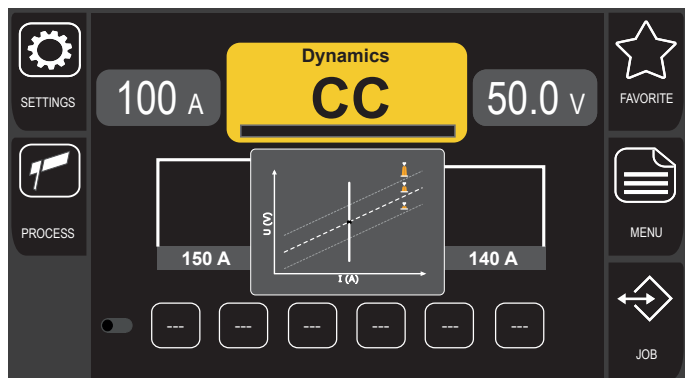

With the "CC" (constant current) setting, the set welding current is supplied in a constant manner. This setting is particularly suitable for welds made with basic, rutile and stainless steel electrodes.

With the "Dyn" setting, the power delivered is kept constant (lifting the electrode increases the arc voltage but decreases the current delivered). This setting is particularly suitable for welds made with cellulose electrodes for root passes on pipes and aluminium electrodes to improve arc stability, especially at low current values.

Adjustment range: minimum (DC direct current) - default (DC) - maximum (Dyn)

5.2.2 MMA parameters (main screen)

From the main screen it is possible to quickly access and set other welding parameters, in addition to those present in the parameters menu.

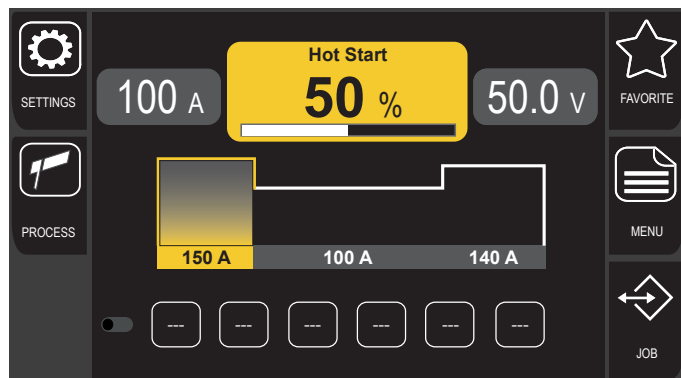
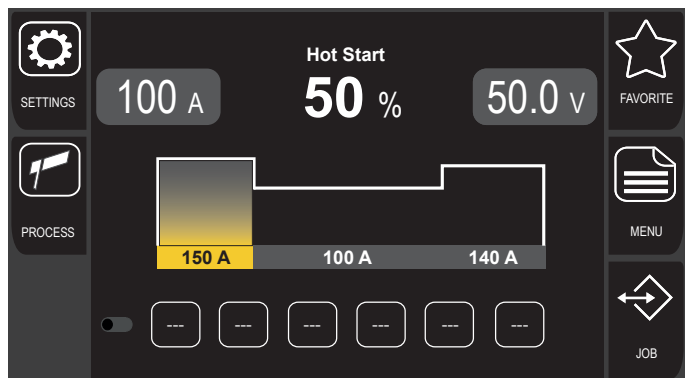

1. Turn the encoder to select the parameter to be modified.
The selected parameter appears on the screen and is highlighted in the graph.
2. Press the encoder button to enter parameter editing mode.

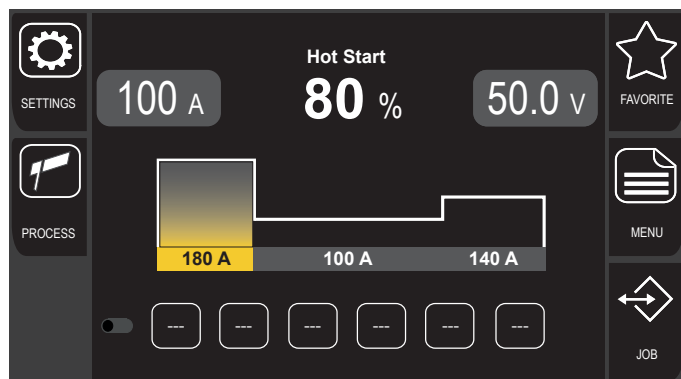
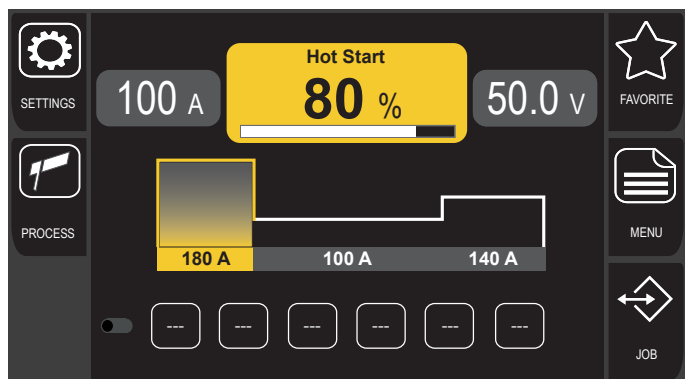

3. Turn the encoder to set the desired value.
The scroll bar below the value shows the available adjustment range. The graph changes according to the set value.
4. Press the encoder key to confirm.

ENGLISH

The modifiable parameters are as follows.



HOT START

This parameter aids electrode melting at the time of ignition. It is set as a percentage referring to the WELDING CURRENT value. The value is limited to 250A max.

Adjustment range: minimum (0 %) - default (50 %) - maximum (100 %)



ARC FORCE

This parameter helps to avoid electrode sticking during welding. It is set as a percentage referring to the WELDING CURRENT value.

Adjustment range: minimum (0 %) - default (40 %) - maximum (200 %)

JOB

This parameter is used to select a job previously created by the user.

6 ARC AIR GOUGING

6.1 ARC AIR PROCESS SELECTION

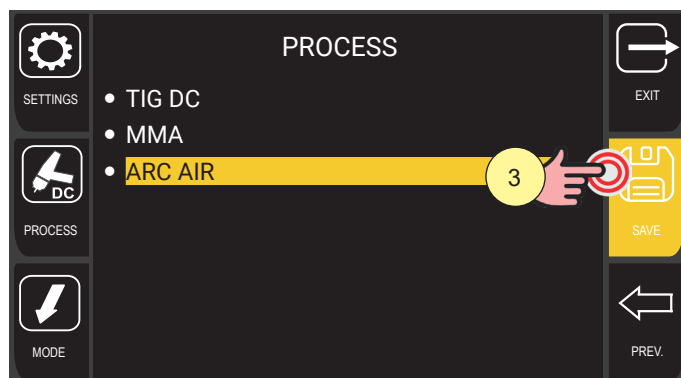
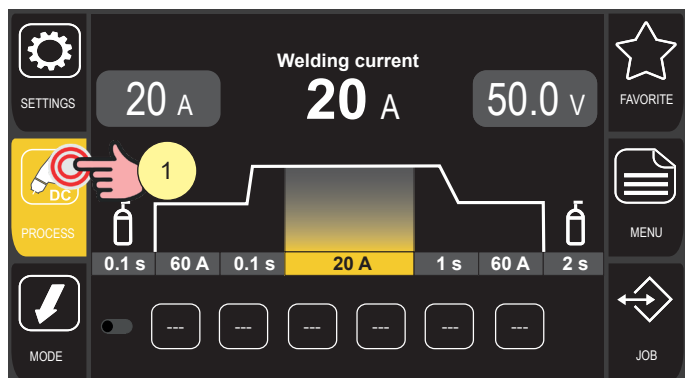

1. Press the [PROCESS] key.
2. Turn the encoder to select the desired setting.
Select the following path: ARC AIR
3. Press the [ENCODER] key or the [SAVE] key to confirm.

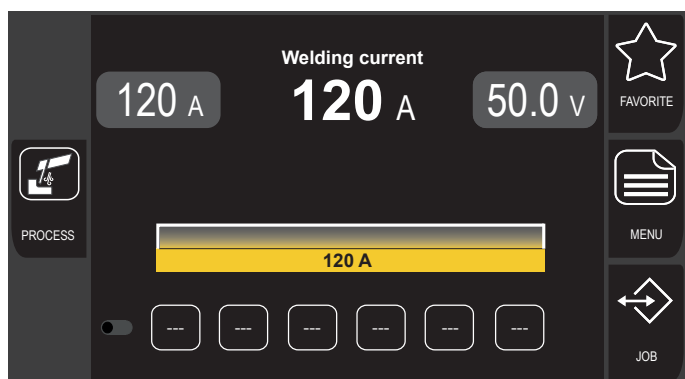

The icon appears in the process key .

ENGLISH

6.1.1 ARC AIR parameters (main screen)

From the main screen it is possible to quickly access and set the welding parameters.

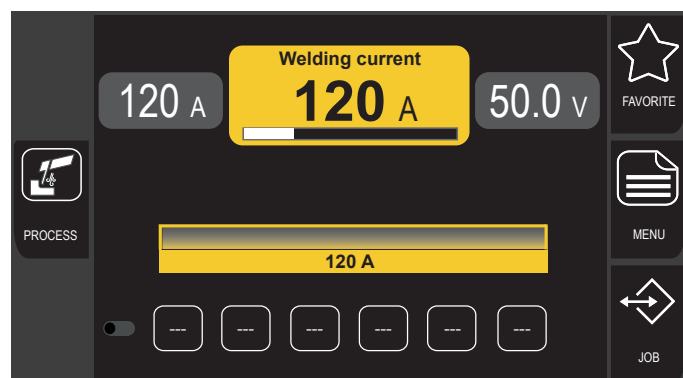
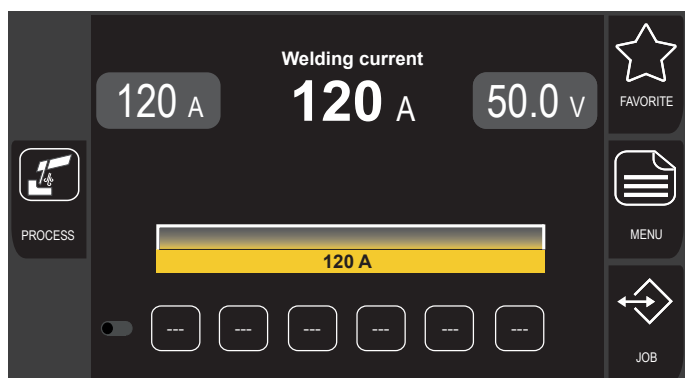

1. Turn the encoder to select the parameter to be modified.
The selected parameter appears on the screen and is highlighted in the graph.
2. Press the encoder button to enter parameter editing mode.

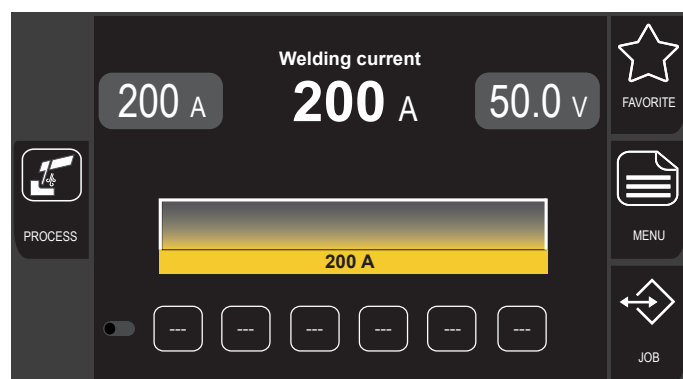
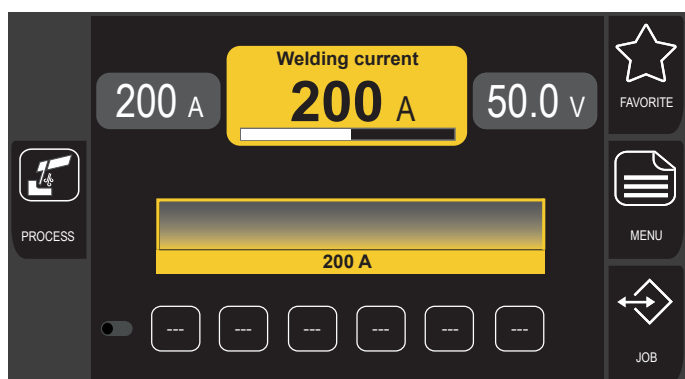

3. Turn the encoder to set the desired value.
The scroll bar below the value shows the available adjustment range. The graph changes according to the set value.
4. Press the encoder key to confirm.

7 FAVORITES KEY SETTING

It is possible to assign a specific function to the [SHORTCUT] keys  from a predefined list.

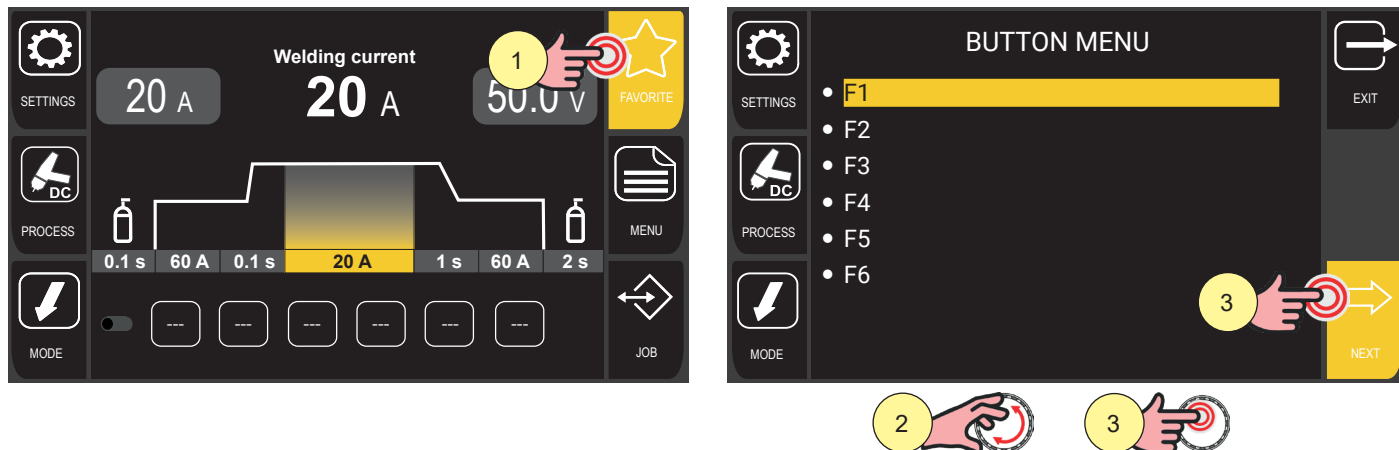

1. Press the [FAVORITES] key; the BUTTON MENU appears.

i Information Within the menu screen, it is possible to select the key [Fn°] to which to assign a specific function.

Press and hold the desired  [SHORTCUT] key for 3 seconds to directly enter the function assignment screen.

2. Turn the encoder to select the desired key.
3. Press the encoder key or the [NEXT] key to confirm.

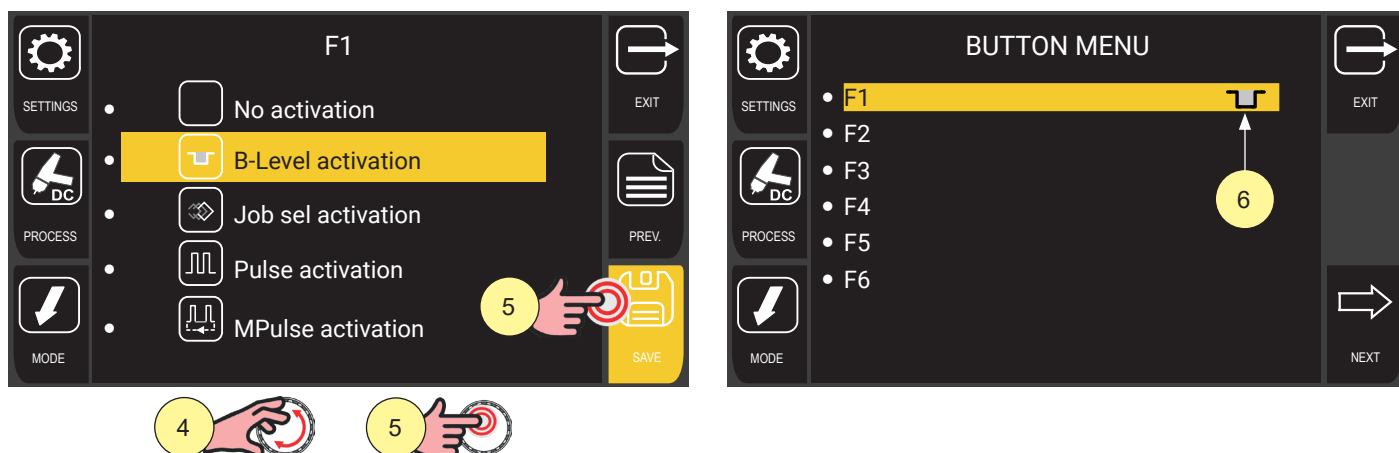

4. Rotate the encoder to select the desired function from the available options:
[No activation, B-Level activation, Job sel activation, Pulse activation, MPulse activation, QStart activation, QSpot activation, Mixed activation, Job load activation]
5. Press the encoder button or the [SAVE] key.
6. The assignment of the function to the shortcut key is displayed.

Press the [EXIT] key to exit the screen.

ENGLISH

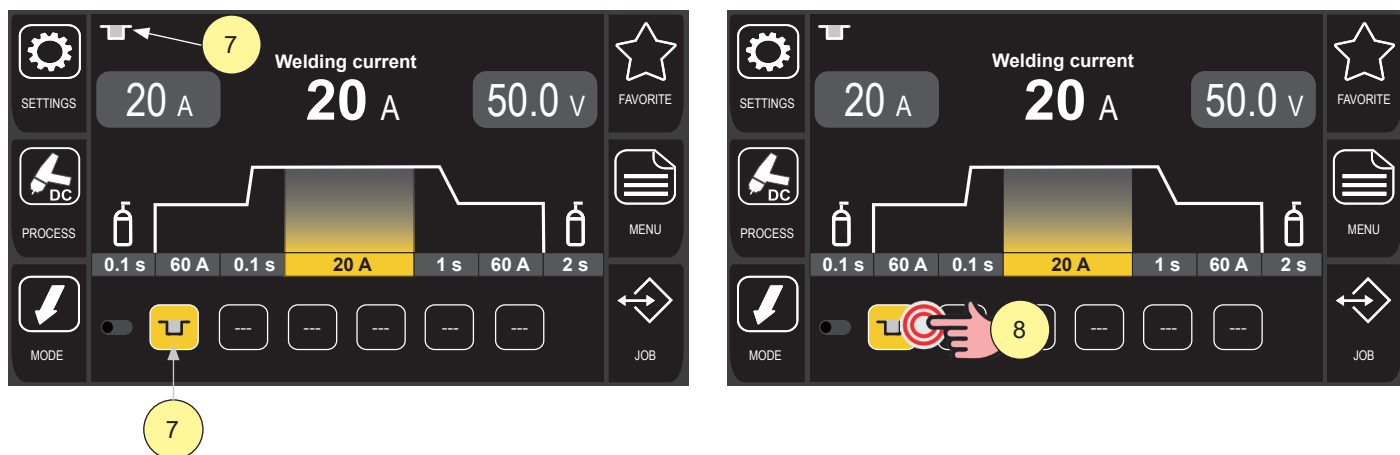

7. Once the desired function is associated with the [SHORTCUT] key, the function icon is displayed both in the [BUTTON] menu and on the key in the main screen.
8. Press the key with the associated function to activate/deactivate the function.

When the function is active the background of the key is highlighted.

8 JOBS MANAGEMENT

Personalised welding settings, or JOBS, can be saved in memory locations and subsequently uploaded. The job is the saving of the image of all the parameters set in the device. Parameters include wire speed, arc length, inductance/dynamics, slopes, process, program used, special functions, etc.

The settings of the SETUP menu are not saved.

There are 100 JOBS available.

This function is available when welding mode is not active.

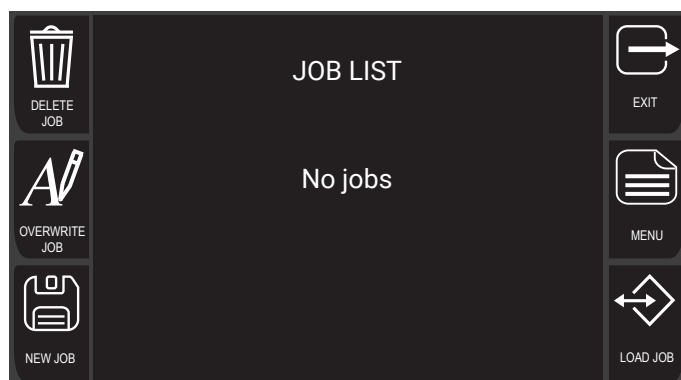
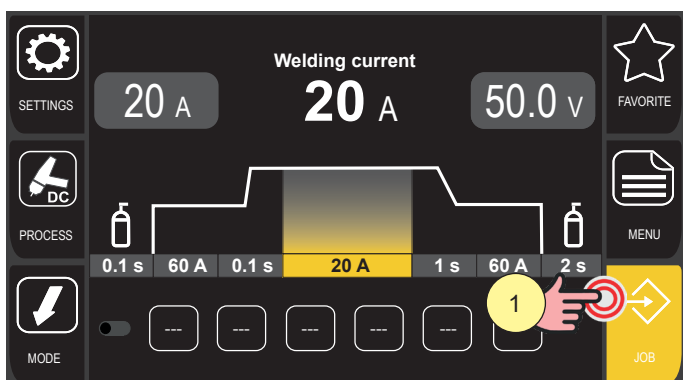

1. To enter the JOB menu, press the [JOB] key.

8.1 CREATE A JOB

Enter the JOB screen.

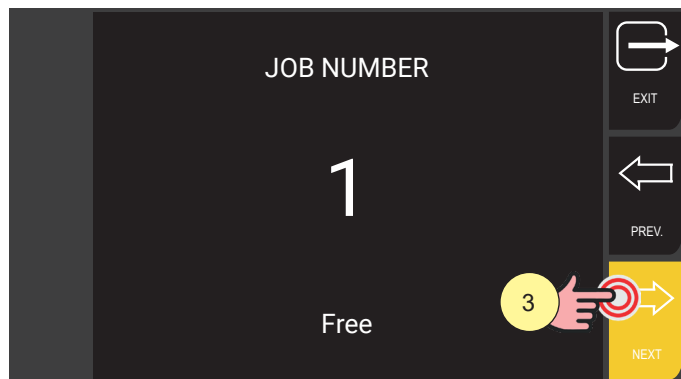
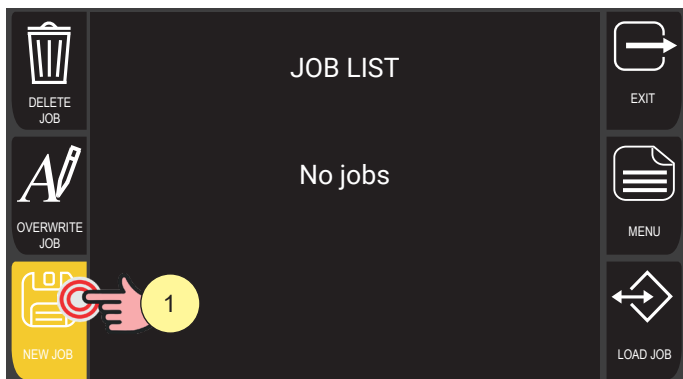

1. Press the [NEW JOB] key.
The screen to select the position of the JOB appears.
2. Select the position of the JOB using the encoder.
3. Press the encoder key or the [NEXT] key to confirm the position.
The keyboard for typing the name appears.

ENGLISH

Keyboard functions

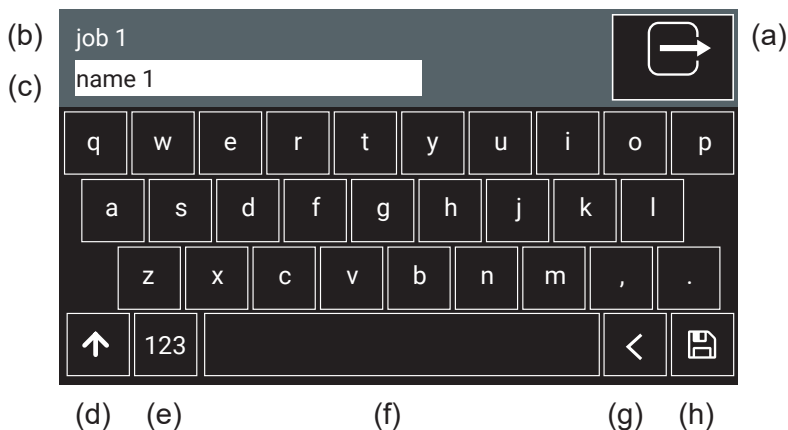

- | | |
|----------------------------|-------------------------------|
| a. exit and cancel changes | e. numbers/special characters |
| b. JOB position | f. space bar |
| c. JOB text | g. delete text |
| d. upper-case | h. save |

i Information The panel is of the touch screen type; settings can be made both by means of the mechanical keys and by touching the icons that appear on the screen.

Name a job



1. Turn the encoder to select the letter on the keyboard.
2. Press the encoder key to confirm the selection.
3. Turn the encoder to select the [SAVE] symbol on the keyboard
4. Press the encoder key to save and exit

Press the [EXIT] key to exit without saving.

8.2 OVERWRITE A JOB

The job overwrite function can be used to overwrite the parameters of a previously saved job (for example: welding voltage or current) after changes have been made from the main screen of the equipment.

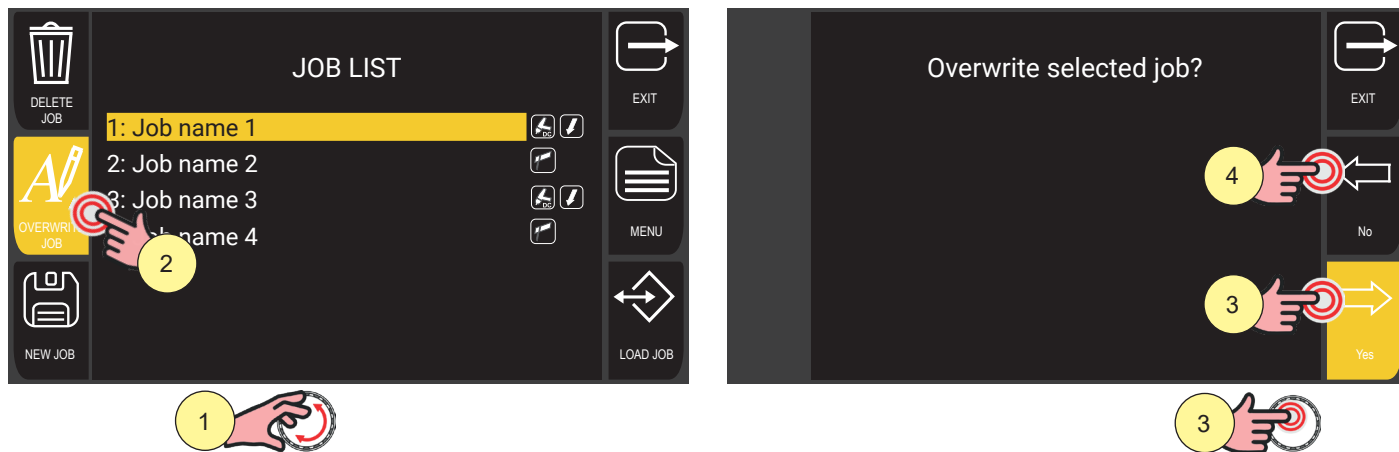

Enter the JOB screen, with the list of stored JOBS.

1. Use the encoder to select the JOB to be overwritten.
2. Press the [OVERWRITE JOB] key.
3. Press the encoder key or the [YES] key to confirm.
4. or press the [NO] key to go back to the previous screen.

Press the [EXIT] key to exit without saving.

ENGLISH

8.3 LOAD A JOB

Enter the JOB screen, with the list of stored JOBs.

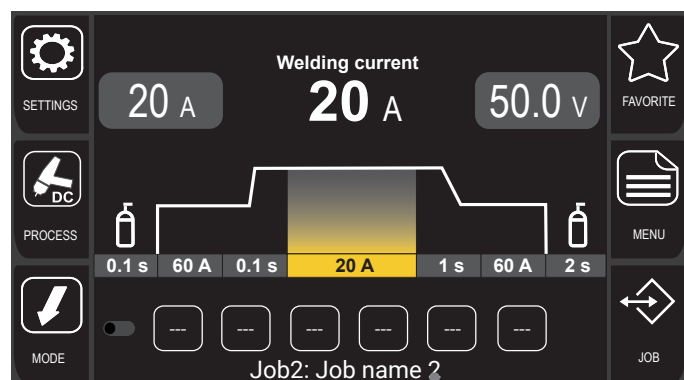
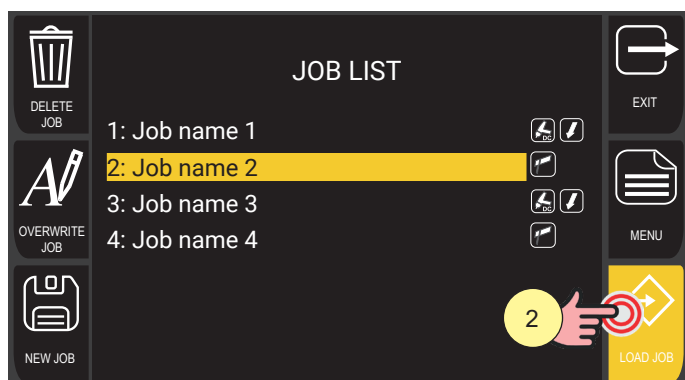

1. Select the JOB to be loaded using the encoder.
2. Press the encoder key or the [LOAD] key to confirm.
3. At the bottom of the main screen, the memory location and text of the loaded job appear.

8.4 DELETING A JOB

Enter the JOB screen, with the list of stored JOBs.

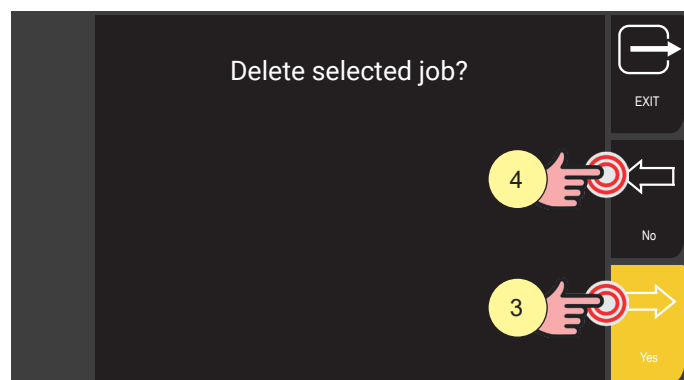
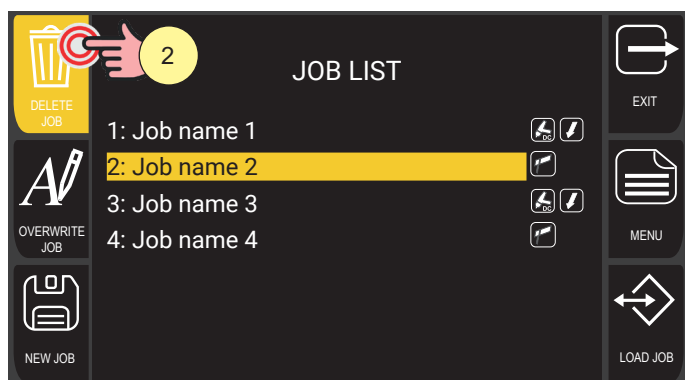

1. Select the JOB to be deleted using the encoder.
2. Press the [DELETE JOB] key.
3. Press the encoder key or the [YES] key to confirm.
4. Press the [NO] key to return to the previous screen.

8.5 EXPORT JOBS

Enter the JOB screen.

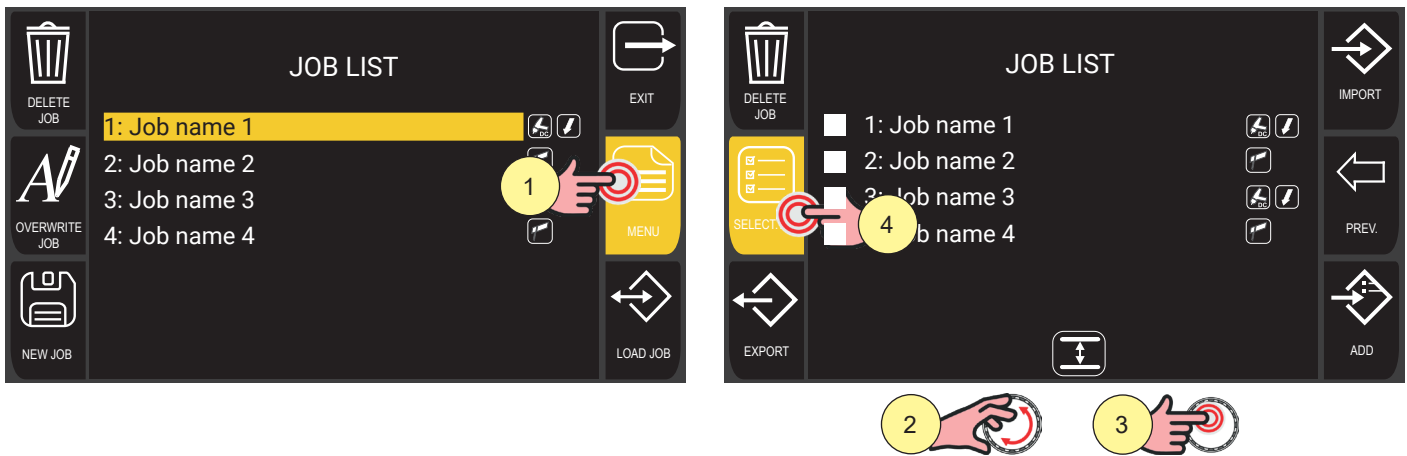

1. Press the [MENU] key.
2. Select the JOB to be exported using the encoder.
3. Press the encoder key to confirm the selection.
4. To select/deselect all JOBS, press the [SELECT ALL] / [DESELECT ALL] key.

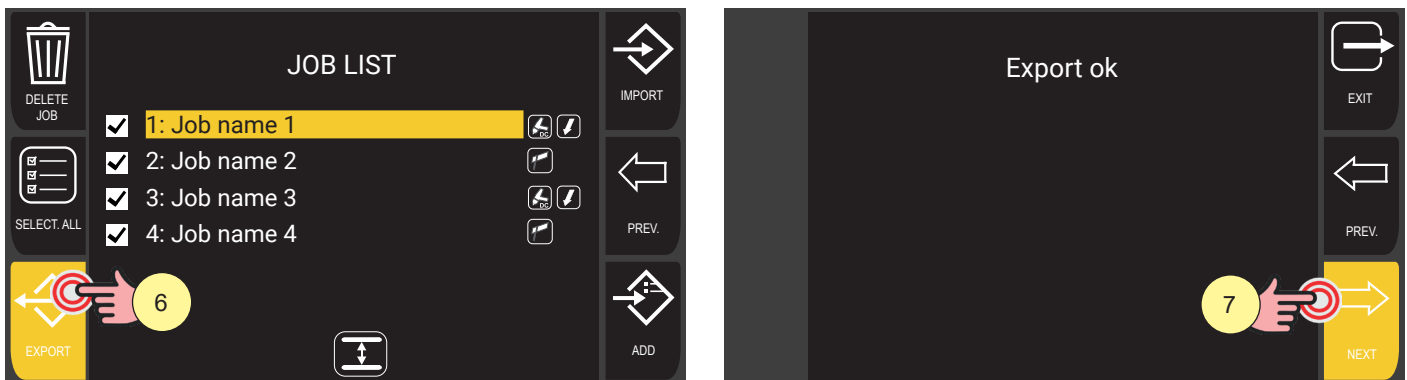

5. Please insert the USB pen drive into the dedicated port.
6. Press the [EXPORT] key to export the files to the USB pen drive.
7. If the export is successful, the "Export OK" message will appear.
8. Press the [OK] key.

Press the [PREV.] key to go back to the previous screen.

Press the [EXIT] key to go back to the main screen.

ENGLISH

8.6 IMPORT JOBS

Enter the JOB screen.

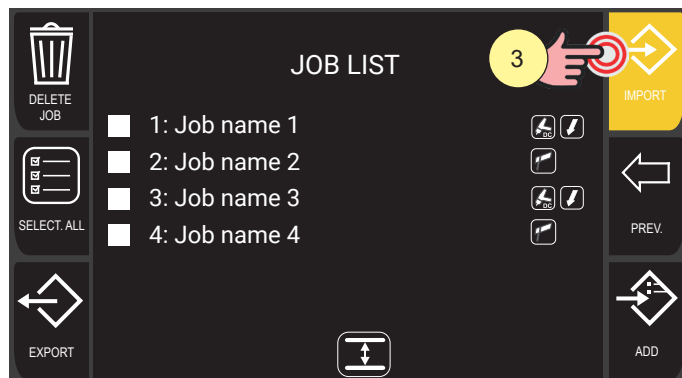
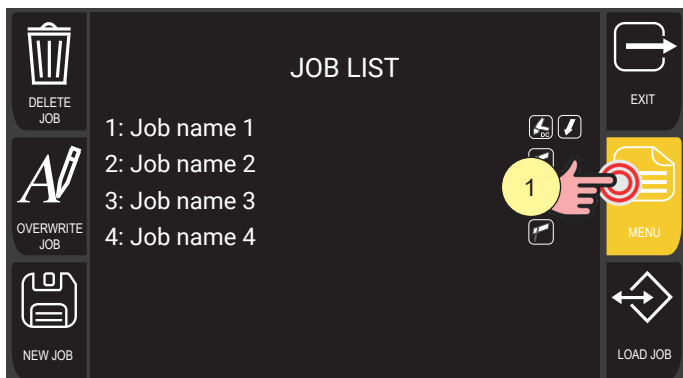

1. Press the [MENU] key.
2. Please insert the USB pen drive into the dedicated port.
3. Press the [IMPORT] key to import the files from the USB pen drive.

 **NOTICE!** If the files on the USB pen drive occupy the same location as those on the device (see the number before the name), the latter will be overwritten by those on the pen drive.

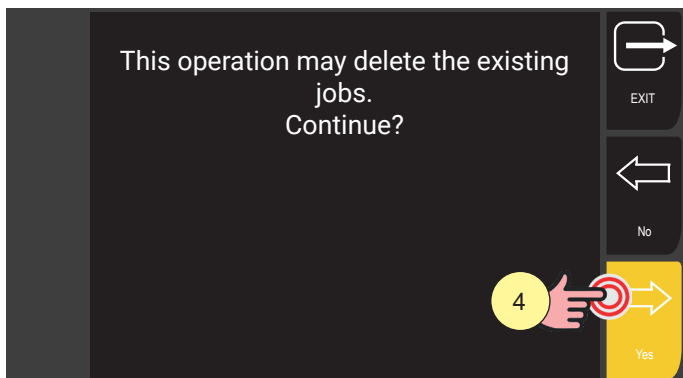

4. Press the [YES] key.

Press the [NO] key to go back to the previous screen.
Press the [EXIT] key to go back to the main screen.

8.7 ADD JOBS

Enter the JOB screen.

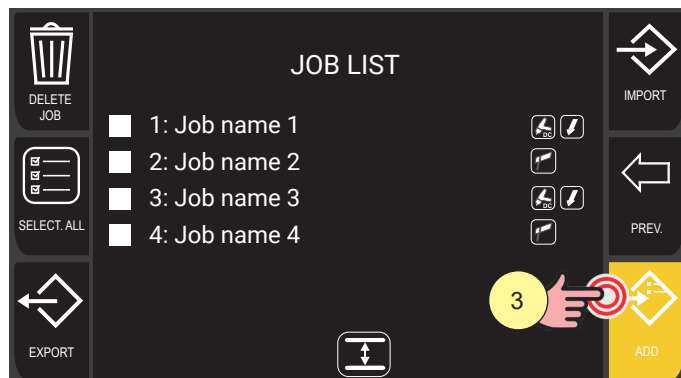
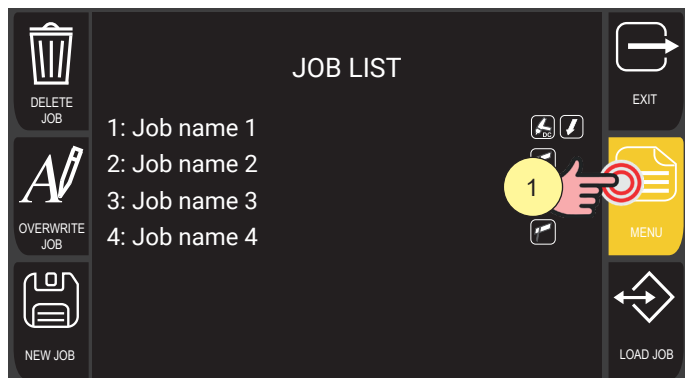

1. Press the [MENU] key.
2. Please insert the USB pen drive into the dedicated port.
3. Press the [ADD] key to add the USB pen drive files to the JOBS in the equipment.

i Information The files in the USB pen drive will be added to those in the equipment, renumbering them and placing them at the bottom of the list.

ENGLISH

8.8 JOB ADJUSTMENT FREQUENCY

For each saved job, it is possible to define a main current adjustment range, which can be changed by the user during welding, keeping the previously loaded job active.

This feature is useful when minor current adjustments are required during welding, but the job must also be used in a subsequent job, without the need to reload it.

Enter the JOB screen.

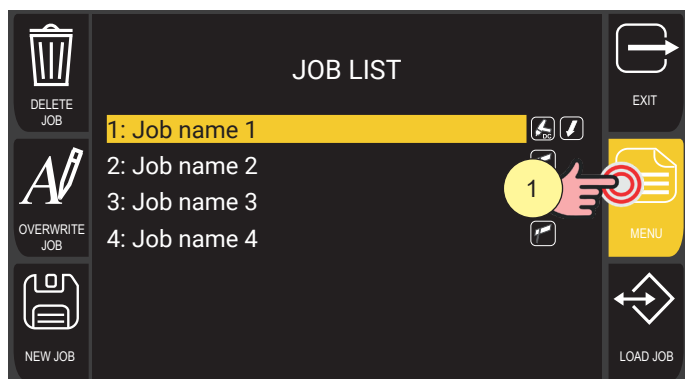

1. Press the [MENU] key.
2. Select the desired JOB using the encoder.
3. Press the  key to access the edit screen.

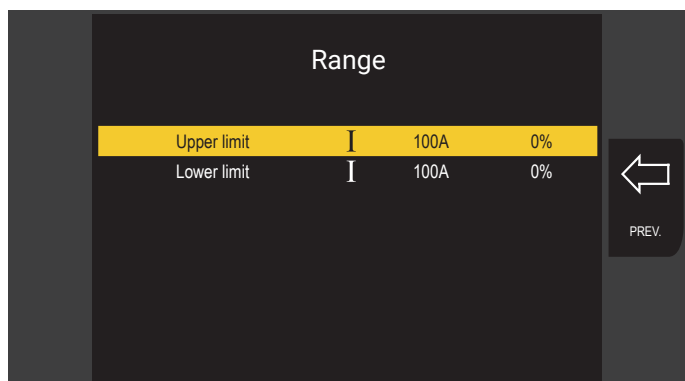

4. Rotate the encoder to select the parameter to be modified. The following parameters are available:
UPPER LIMIT, LOWER LIMIT.
5. Press the encoder key to activate parameter change.
The parameter background is highlighted.
6. Turn the encoder to set the desired value.
Adjustment range:
UPPER LIMIT: minimum (0%) - default (0%) - maximum (+50%)

LOWER LIMIT: minimum (0%) - default (0%) - maximum (-50%)
7. Press the encoder key to confirm the setting change.

The parameter background is no longer highlighted.

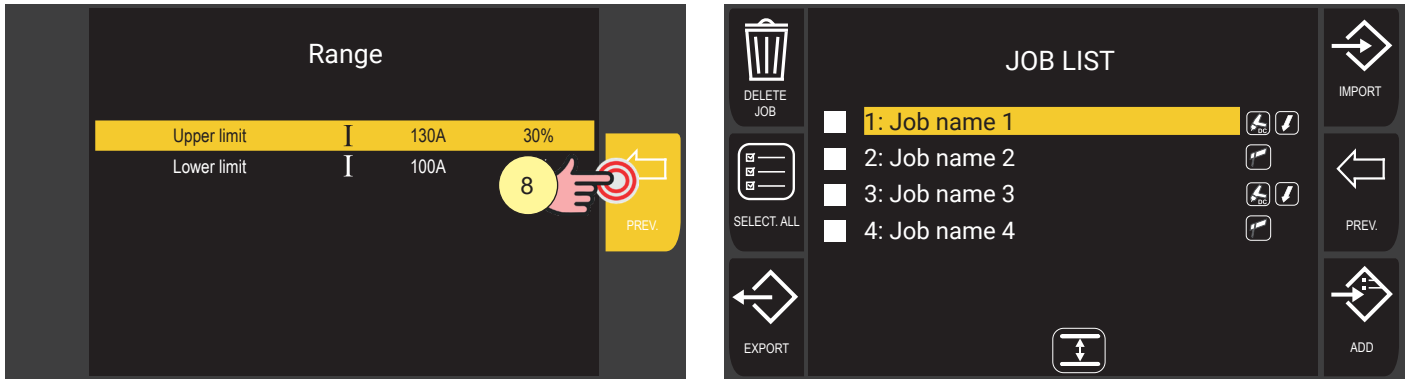

8. Press the [PREV.] key to return to the job list.

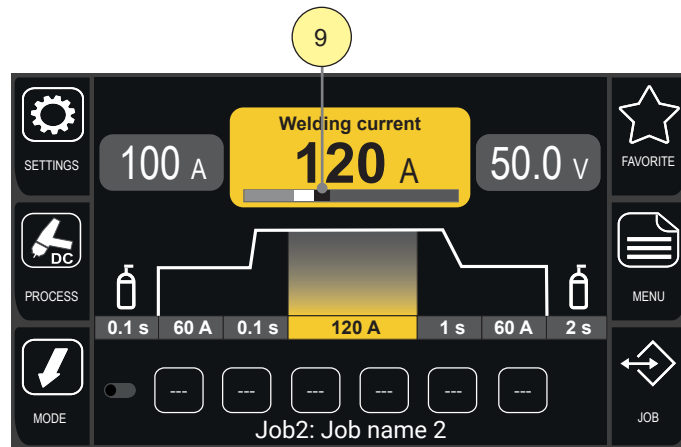

9. When a job with an active setting range is loaded, the possible welding current setting range is displayed graphically in the scroll bar below the numerical value.

ENGLISH

9 USER MANAGEMENT

The user menu is used to create user profiles for operators using the same welding current generator. Different levels of authorisation can be created for use of the device, depending on the operator's qualifications and training.

User identification is achieved using NFC keys, which are read by the current generator when held close to the designated area on the front panel identified by the symbol ((Ⓜ)).

NFC keys can be in the form of a card, keychain, token or other media; in this manual, the generic term "NFC key" is used.

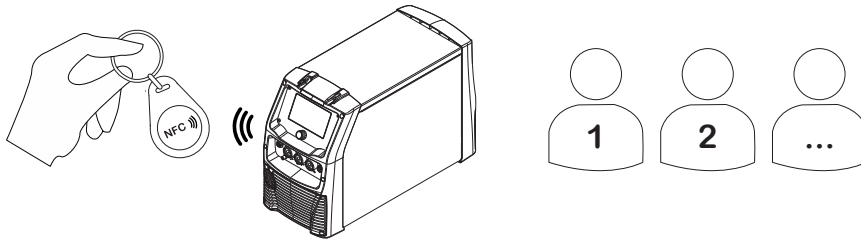

 **NOTICE!** For correct authorisation management, a different NFC key must be assigned to each user.

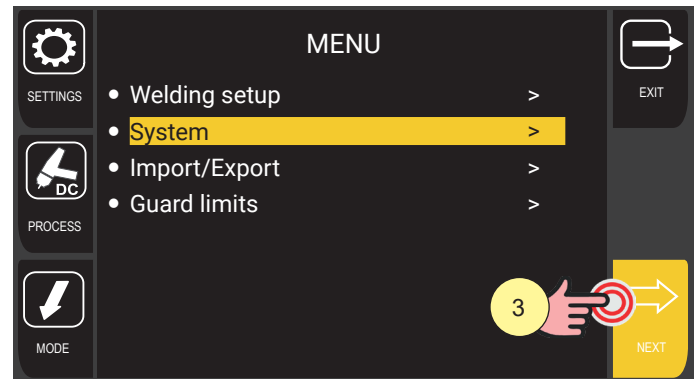
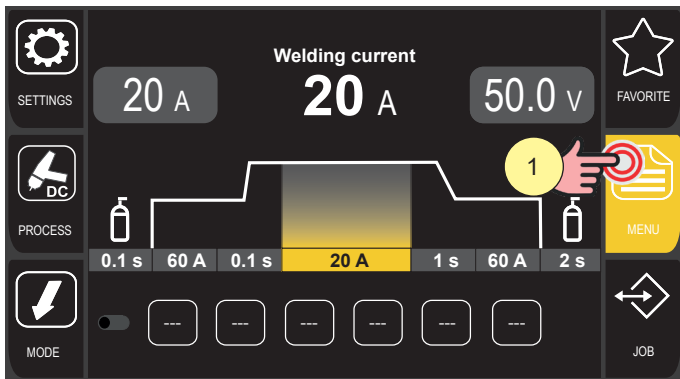

1. Press the [MENU] key.
2. Turn the encoder to select the desired setting.
Select the following path: System>
3. Press the encoder key or the [NEXT] key to confirm.

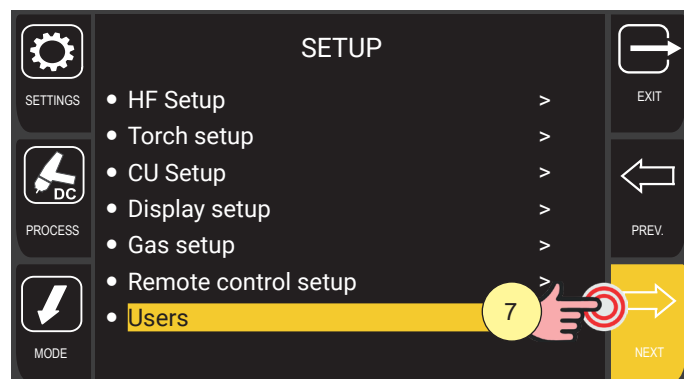
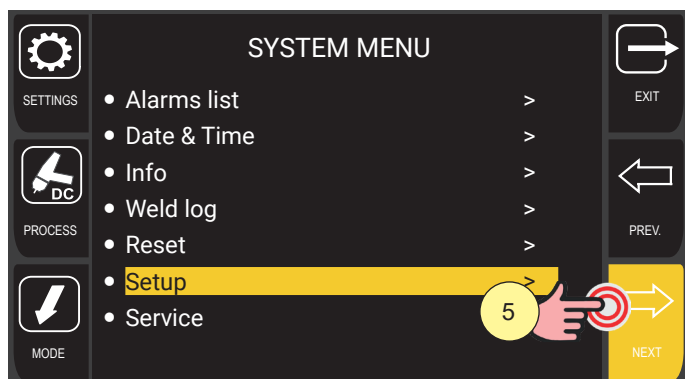

4. Turn the encoder to select the desired setting.
Select the following path: Setup>
5. Press the encoder key or the [NEXT] key to confirm.
6. Turn the encoder to select the desired setting.
Select the following path: Users>
7. Press the encoder key or the [NEXT] key to confirm.

9.1 AUTHORISATION LEVELS

The following authorisation levels can be assigned to users.

► Administrator

This is the user with the highest authorisations for the generator's functions. By default, this user is authorised to weld and lock the generator settings. This user can create new users and manage the authorisations of existing users.

The Administrator user is unique; additional user profiles with these characteristics cannot be created.

► Default

This is the standard user that is loaded onto the generator if no other user profile has been created or when no other user is logged in. By default, this user is authorised to weld and lock the generator settings.

The Default user is unique; additional user profiles with these characteristics cannot be created.

► Users

These are all users created by the administrator. By default, they have the same authorisations as the "Default" user; additional authorisations can be assigned using the appropriate selection menu.

Two different types of users can be created:

- **simple user**: is the standard user with more limited permissions;
- **user admin**: is a user authorised to manage other users registered on the generator (create, delete, modify permissions).

ENGLISH

9.2 ASSOCIATING AN NFC KEY

The procedure is used to associate an NFC key with existing users.

i Information It is not possible to associate an NFC key with the "Default" user.

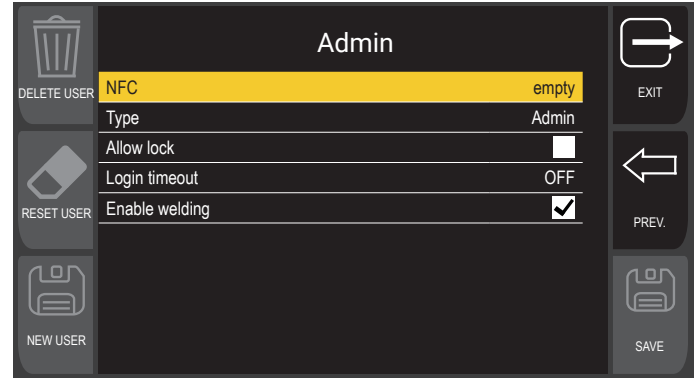
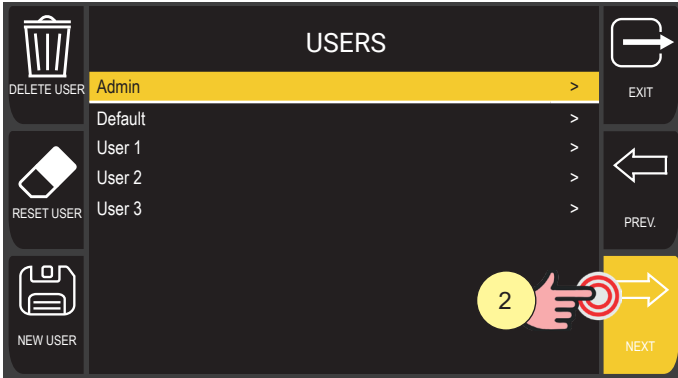

1. Turn the encoder to select the desired user.
2. Press the encoder key or the [NEXT] key to confirm.
3. Turn the encoder to select the NFC setting.
4. Press the encoder key to activate parameter change. The parameter background is highlighted.

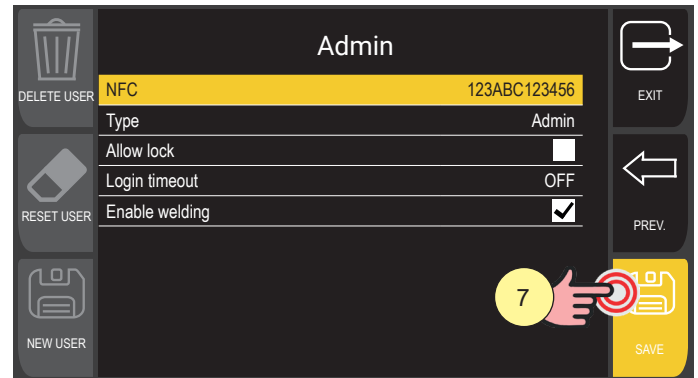
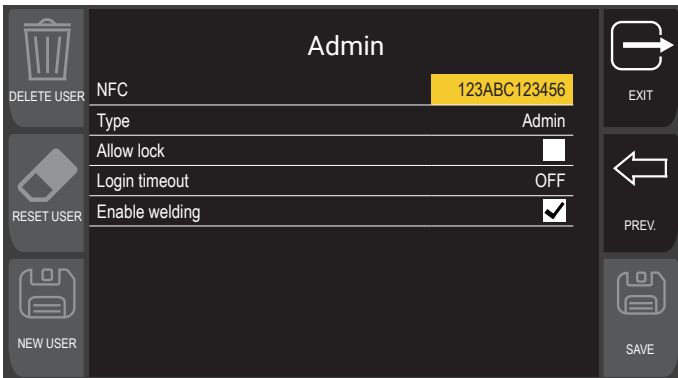
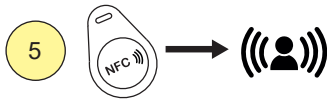

5. Hold a not registered NFC key close to the reading area on the generator. If the NFC key is recognised correctly, the corresponding alphanumeric code appears on the display.
6. Press the encoder key to confirm.
7. Press the [SAVE] key to complete the operation.

NOTICE! With certain user permission settings, losing the administrator NFC key may render the device unusable.

It is advisable to keep the administrator NFC key in a safe place, separate from the location where the current generator is used.

9.3 USING AN NFC KEY

The NFC key associated with a user allows access to the current generator with the settings defined by the administrator for that particular profile.

The NFC key also allows locking of the generator so that other users cannot access and change the current settings.

Accessing the generator

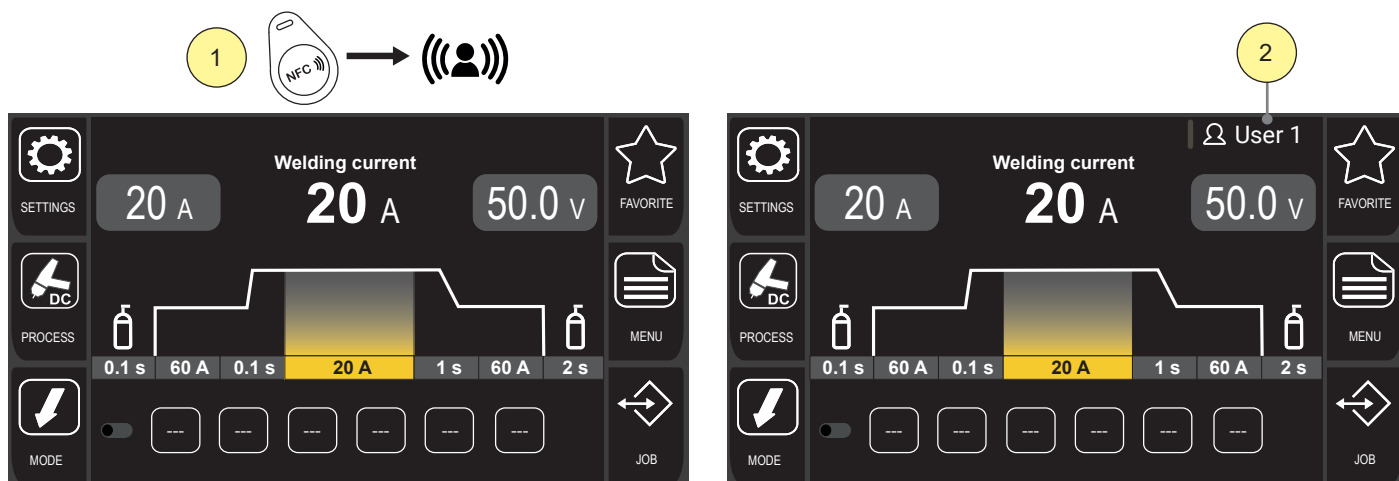

1. Hold a registered NFC key near the reading area on the generator.
2. The name of the user associated with the NFC key is displayed in the upper-right corner of the screen.

Locking the generator

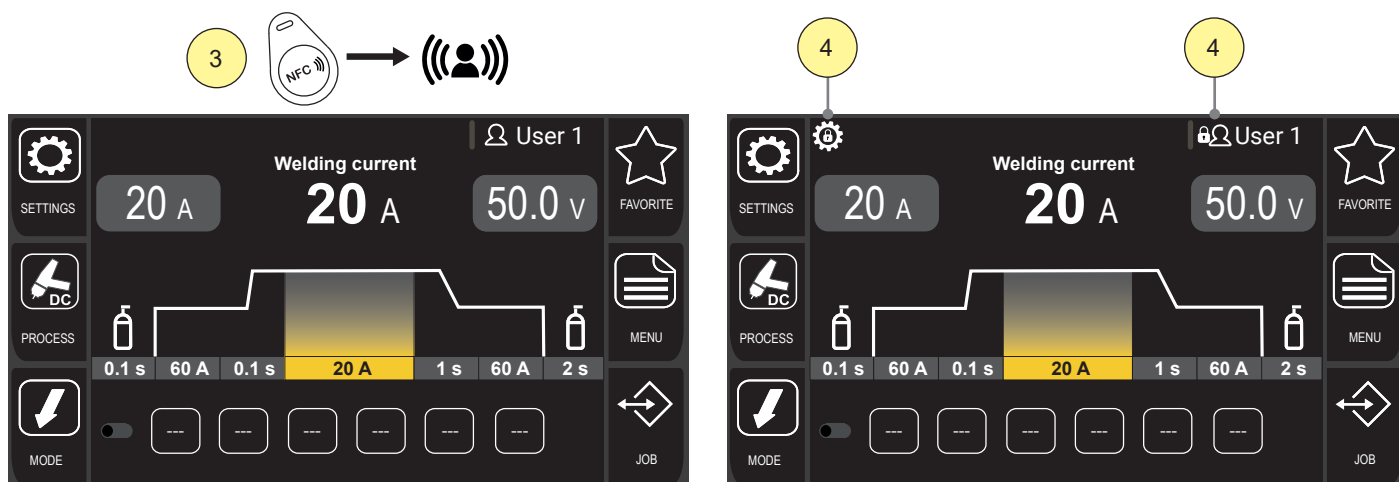

3. After logging in, hold your NFC key near the reading area on the generator again.
4. The generator locks and the locked user and parameter lock icons appear in the notification bar.

To unlock the generator, bring your NFC key close to the reading area on the generator again.

NOTICE! Using administrator or "user admin" NFC keys, it is possible to unlock the generator after it has been locked by a "simple user".

ENGLISH

9.4 DELETING AN NFC KEY

It is possible to delete the code of an NFC key previously associated with a user.

This procedure can only be performed by a user logged in with administrator or user admin permissions.

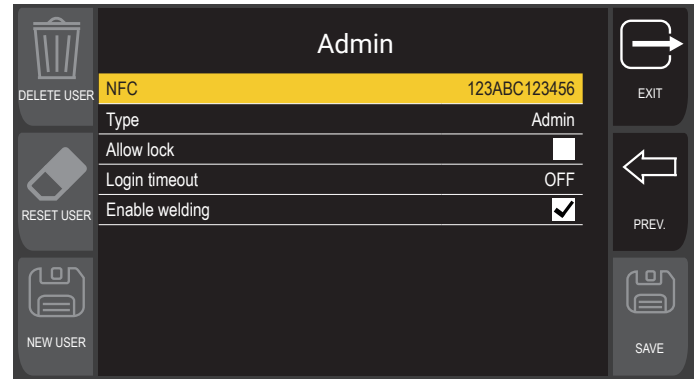
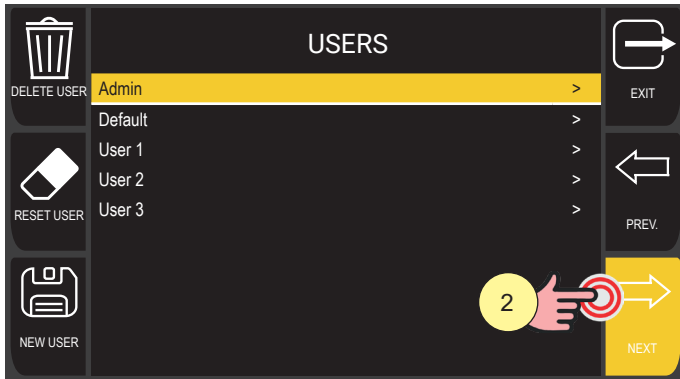

1. Turn the encoder to select the desired user.
2. Press the encoder key or the [NEXT] key to confirm.
3. Turn the encoder to select the NFC setting.
4. Press the encoder key to activate parameter change. The parameter background is highlighted.

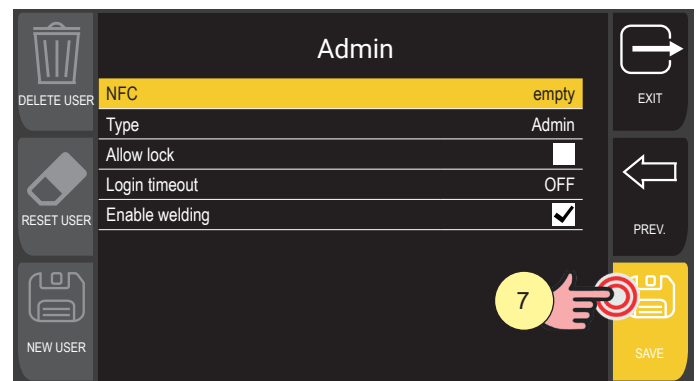
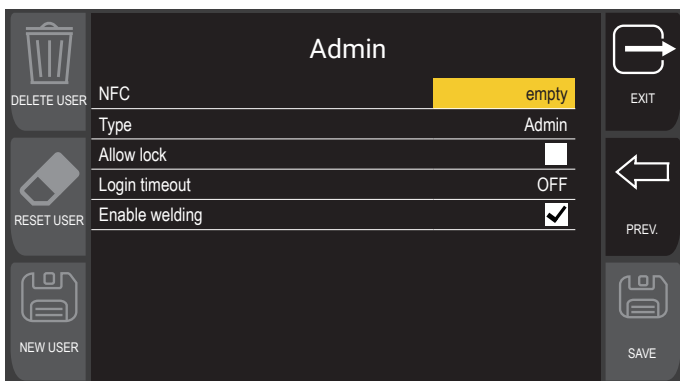
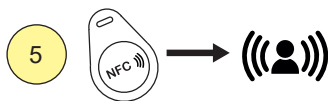

5. Hold the NFC key corresponding to the previously registered code close to the reading area on the generator: the code is deleted. If the NFC key does not match the registered code, the display shows an error message.
6. Press the encoder key to confirm.
7. Press the [SAVE] key to complete the operation.

9.5 CREATING A NEW USER

This procedure can only be performed by a user logged in with administrator or user admin permissions.

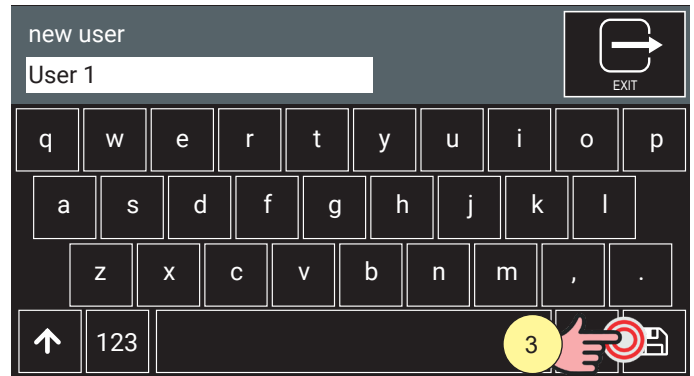
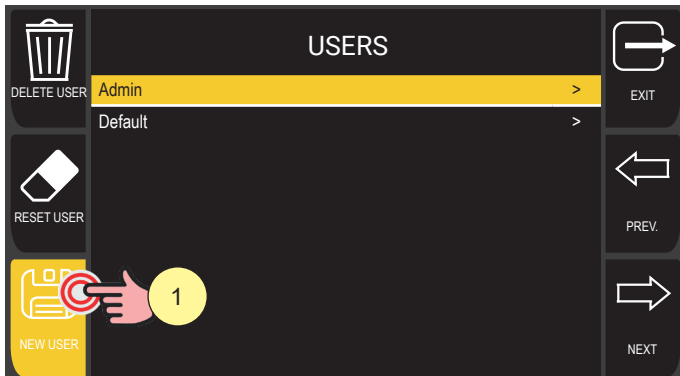

1. Press the [NEW USER] key.
2. Use the on-screen keyboard or the encoder with key to enter the user's name.
3. Use the on-screen keyboard or the encoder with key to press the button with the symbol [SAVE] .

Press the [EXIT] key to exit without saving.

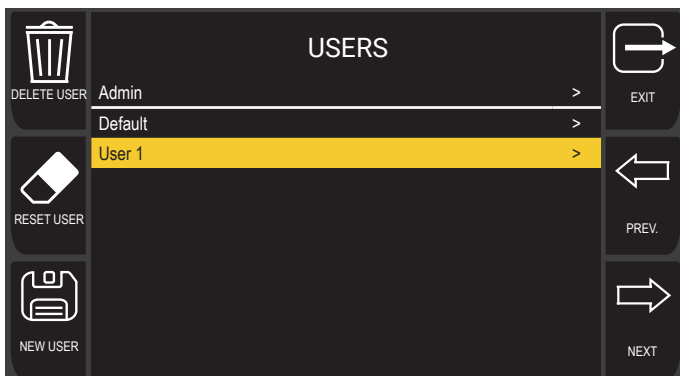

The new user appears in the list of users registered in the generator.

ENGLISH

9.5.1 Copying a user

When creating new users, it is possible to copy previously created user profiles. This will inherit all the assigned permissions, except for the NFC key, which must be different for each user.



1. Turn the encoder to select the user to be copied.
2. Press the [NEW USER] key.
3. A confirmation message appears. Press the [YES] key to continue.

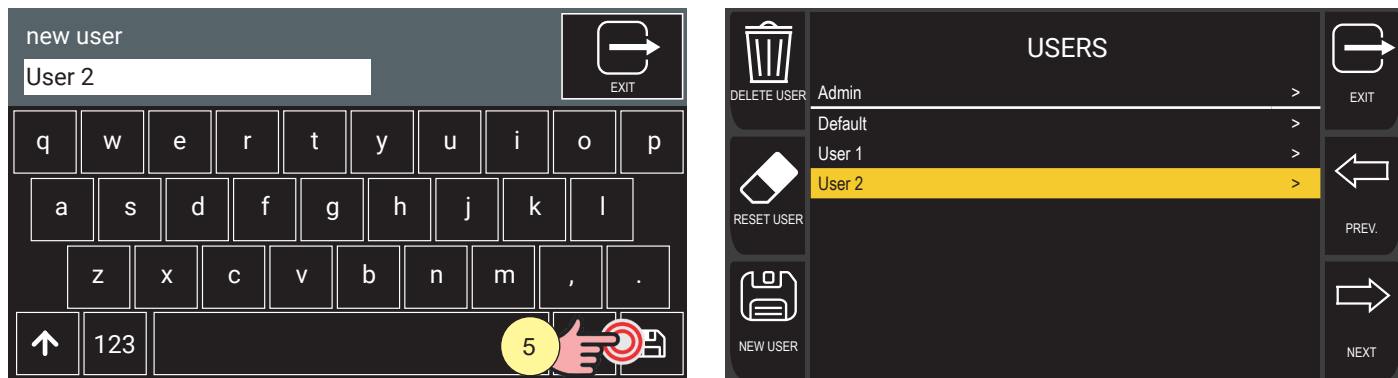

4. Use the on-screen keyboard or the encoder with key to enter the user's name.
5. Use the on-screen keyboard or the encoder with key to press the button with the symbol [SAVE] .

The new user appears in the list of users registered in the generator.

9.6 REMOVING A USER

This procedure can only be performed by a user logged in with administrator or user admin permissions.

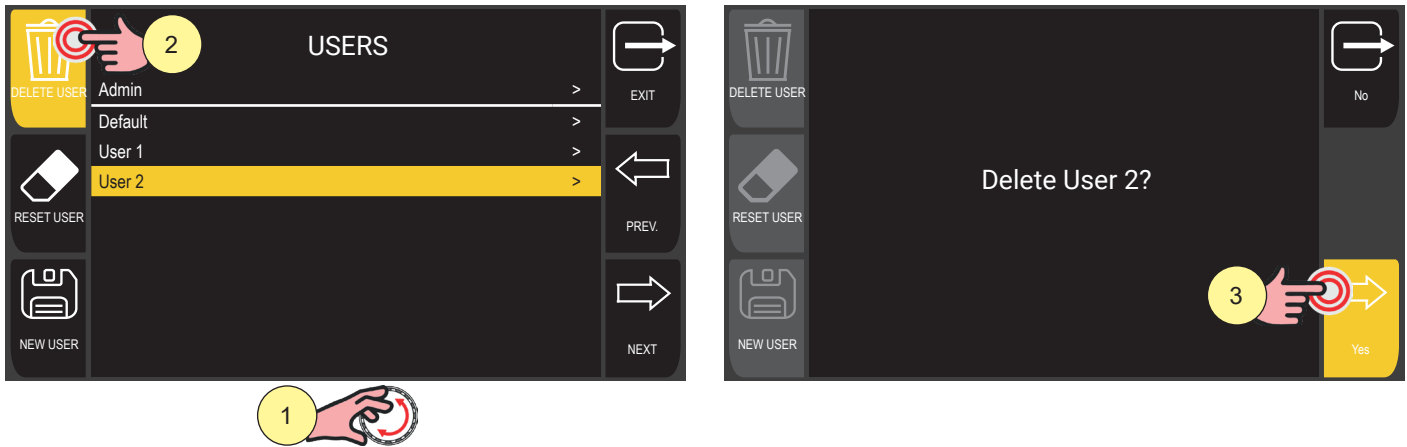

1. Turn the encoder to select the user to be deleted.
2. Press the [DELETE USER] key.
3. A confirmation message appears. Press the [YES] key to continue.

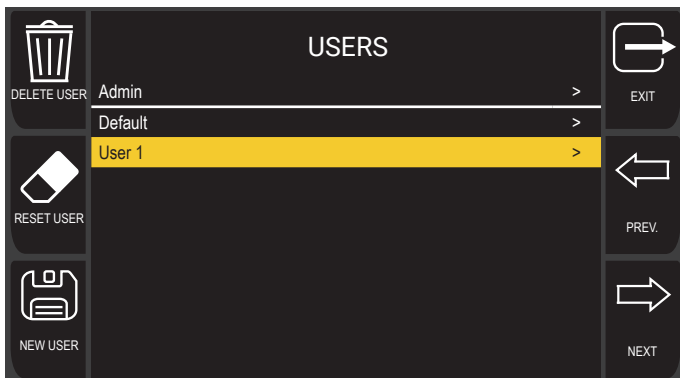

The deleted user is no longer in the generator's registered user list.

The NFC key associated with the deleted user can be used again for another user.

ENGLISH

9.7 RESET USER

The user reset procedure is useful when the generator is locked after a user has logged in and locked it: in this case, all other users with the same level cannot access the machine.

A user with administrator or user admin permissions can log in and reset the currently authenticated user: the generator enters the locked state with the "Default" user authenticated so that all other users with the same or lower authorisation level can log in again with their NFC key.

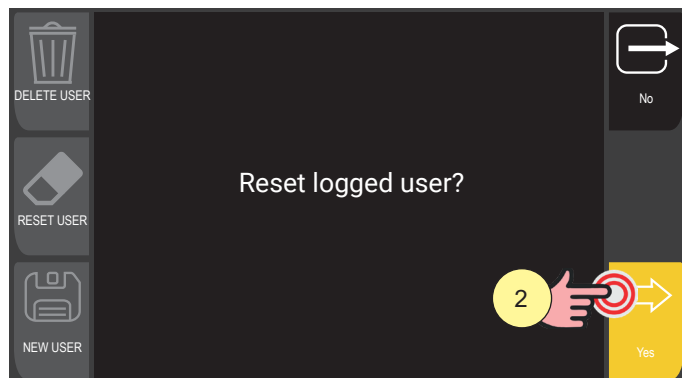
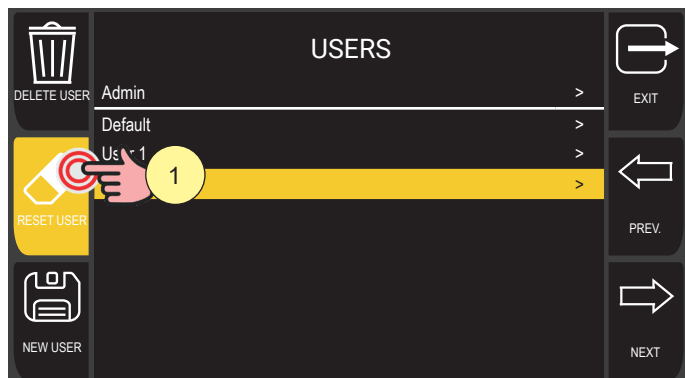

1. Press the [RESET USER] key.
2. A confirmation message appears. Press the [YES] key to continue.

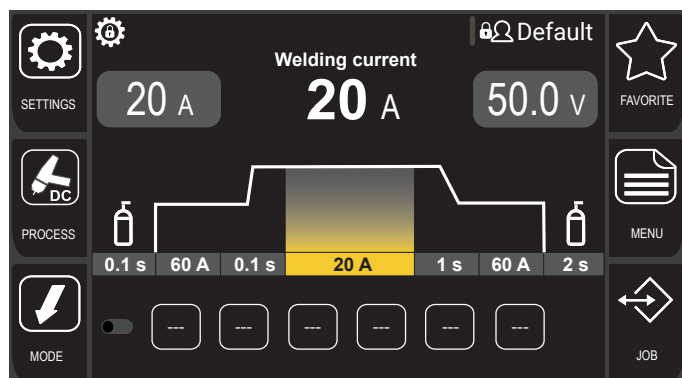
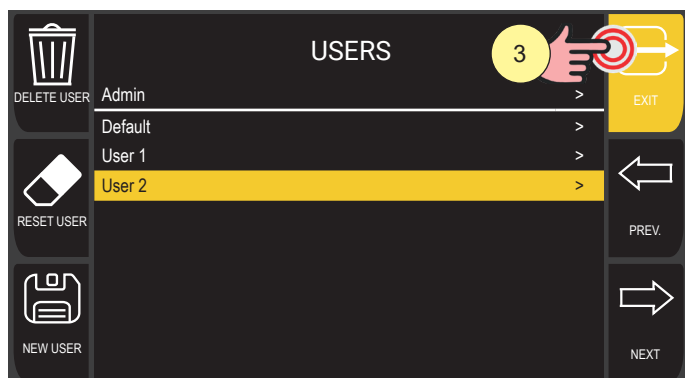

3. Press the [EXIT] key.
4. The display returns to the home screen. The generator is locked with the "Default" user authenticated.

9.8 MANAGING USER PERMISSIONS

For each created user, it is possible to define different permissions for access to the generator menu. This procedure can only be performed by a user logged in with administrator or user admin permissions.

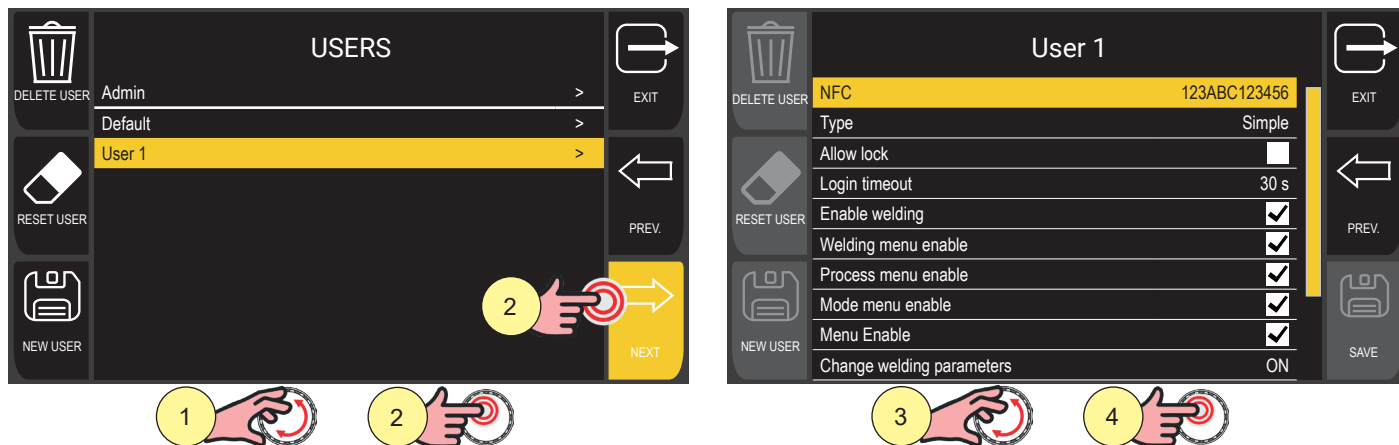

1. Turn the encoder to select the desired user.
2. Press the encoder key or the [NEXT] key to confirm.
3. Turn the encoder to select the parameter to be modified.
 - For parameters with a checkbox, press the encoder key to enable or disable the setting.
 - For text-type parameters, press the encoder key to enable parameter editing. The parameter background is highlighted. Turn the encoder to set the desired value. Press the encoder key to confirm the setting change. The parameter background is no longer highlighted.

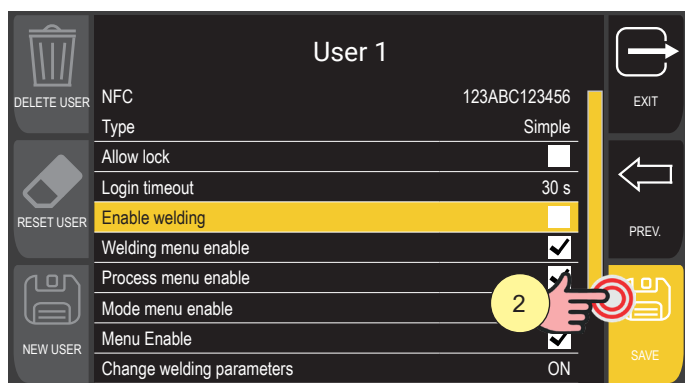

4. Press the [SAVE] key to confirm.

Press the [PREV.] key to go back to the previous screen.
Press the [EXIT] key to go back to the main screen.

ENGLISH

The permissions that can be modified are as follows.

NFC

The alphanumeric code of the NFC key associated with the user is displayed. To associate a new NFC key, follow the procedure described in the section 9.2.

TYPE

This option defines whether the user is of "simple" or "user admin" type (see section 9.1).

ALLOW LOCK

If this option is enabled, the user can lock the generator with their NFC key.

LOGIN TIMEOUT

This option defines a time after which the user is automatically logged out in the event of inactivity and the generator enters the locked state with the "Default" user logged in.

Adjustment range: OFF - 30 s - 1 m - 5 m - 10 m - 30 m - 1h - default (OFF)

ENABLE WELDING

If enabled, the user can perform welding.

WELDING MENU ENABLE

If enabled, the user can access and modify the welding setup menu.

PROCESS MENU ENABLE

If enabled, the user can access and modify the process menu.

MODE MENU ENABLE

If enabled, the user can access and modify the torch trigger menu.

MENU ENABLE

If enabled, the user can access the general generator menu.

CHANGE WELDING PARAMETERS

This option defines whether the user is authorised to modify welding parameters. Modification of all parameters or just of jobs can be blocked.

Adjustment range: ON - lock all - lock job - default (ON)

JOB MENU ENABLE

If this option is enabled, the user can access and modify the job menu.

JOB SELECTION

If this option is enabled, the user can select jobs.

DISPLAY LAYOUT SAVE

If this option is enabled, the user can modify and save the display layout.

LANGUAGE SAVE

If this option is enabled, the user can modify and save the display language.

ENGLISH

10 RESET

This procedure is useful if there is difficulty restoring the factory settings when too many changes have been made to the welding parameters.

10.1 RESET PARAMS

The reset procedure restores the parameter values and settings, except for the following settings:

- System menu settings.
- saved JOBS.

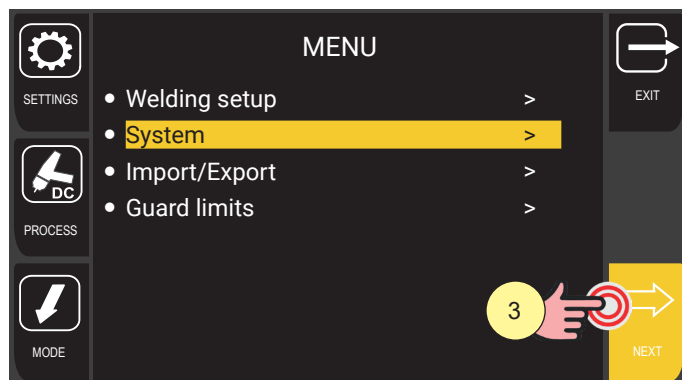
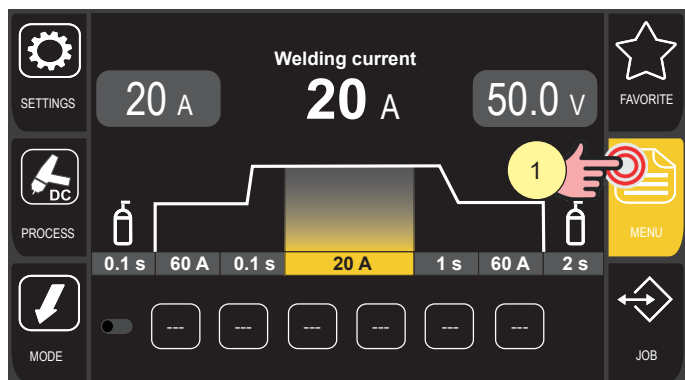

1. Press the [MENU] key.
2. Turn the encoder to select the desired setting.
Select the following path: System>
3. Press the encoder key or the [NEXT] key to confirm.

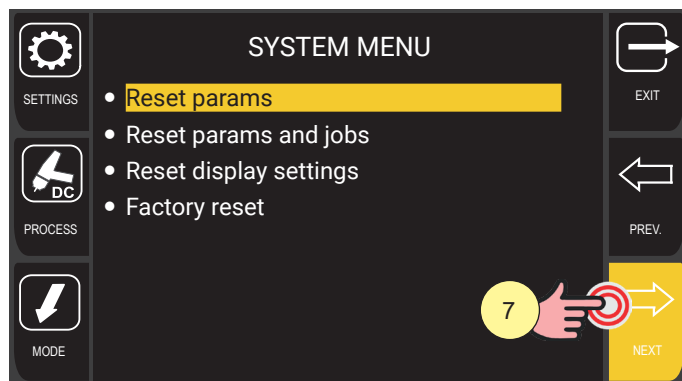
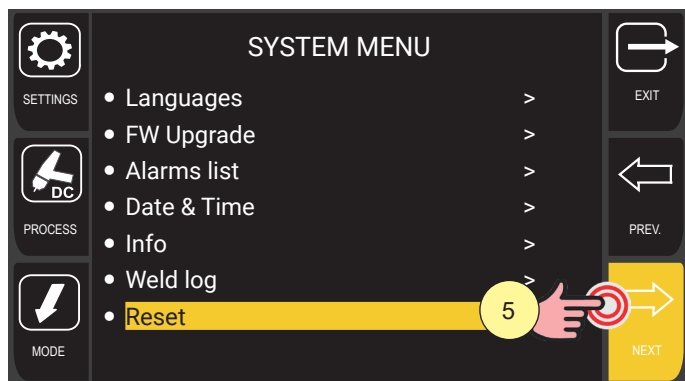

4. Turn the encoder to select the desired setting.
Select the following path: Reset>
5. Press the encoder key or the [NEXT] key to confirm.
6. Turn the encoder to select the desired setting.
Select the following path: Reset params
7. Press the encoder key or the [NEXT] key to confirm.

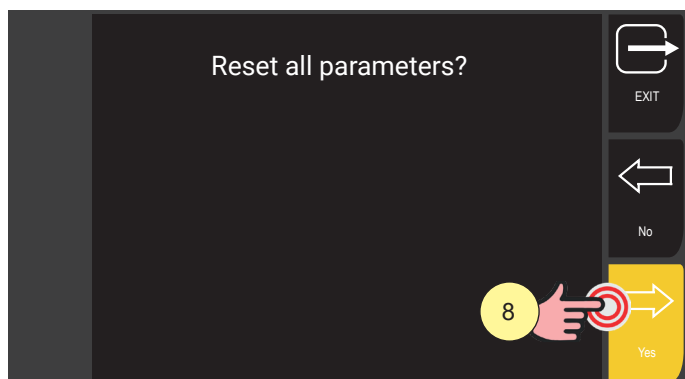

8. Press the encoder key or the [YES] key to confirm.

Press the [NO] key to go back to the previous screen.
Press the [EXIT] key to go back to the main screen.

10.2 RESET PARAMS AND JOBS

The reset procedure completely restores values, parameters, and job memories to the factory settings. All memory locations will be reset and hence all your personal welding settings will be lost.

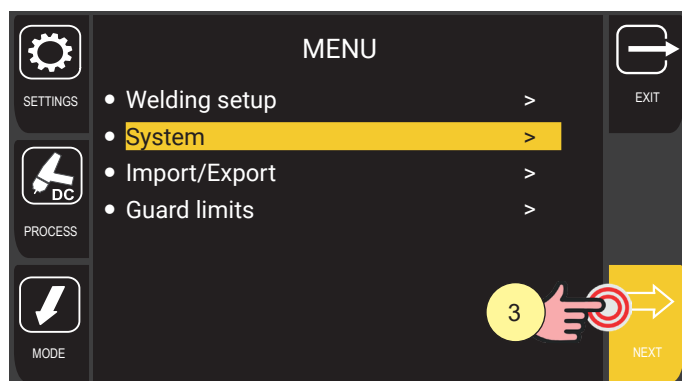
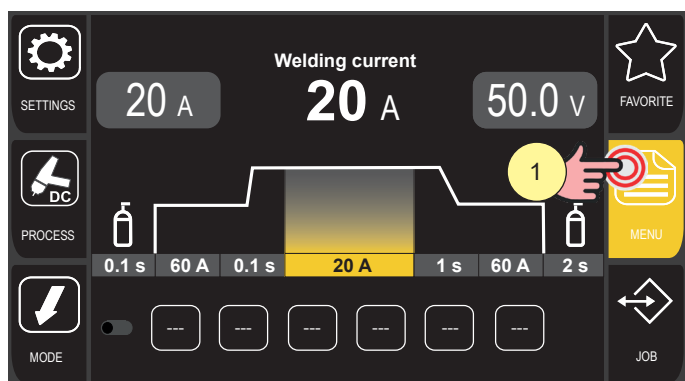

1. Press the [MENU] key.
2. Turn the encoder to select the desired setting.
Select the following path: System>
3. Press the encoder key or the [NEXT] key to confirm.

ENGLISH

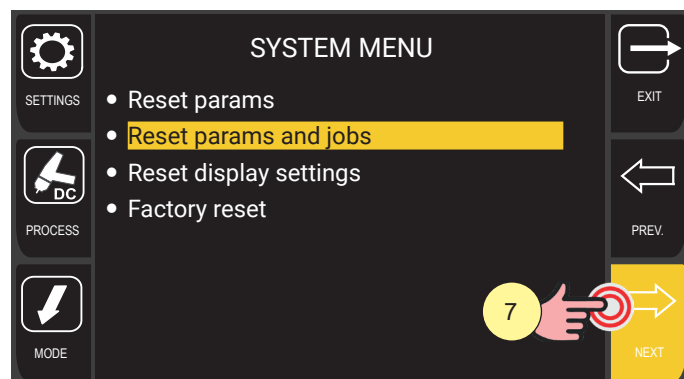
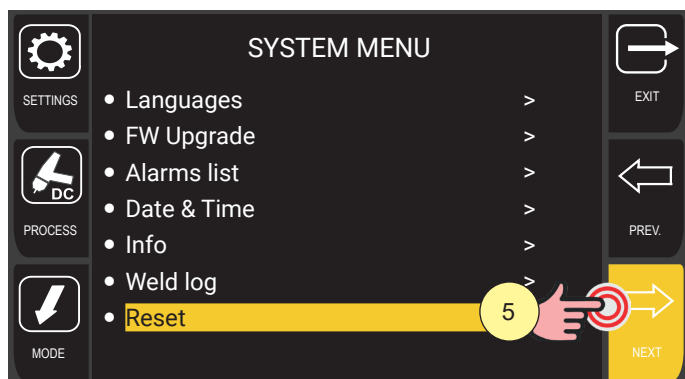

4. Turn the encoder to select the desired setting.
Select the following path: Reset>
5. Press the encoder key or the [NEXT] key to confirm.
6. Turn the encoder to select the desired setting.
Select the following path: Reset params and jobs
7. Press the encoder key or the [NEXT] key to confirm.

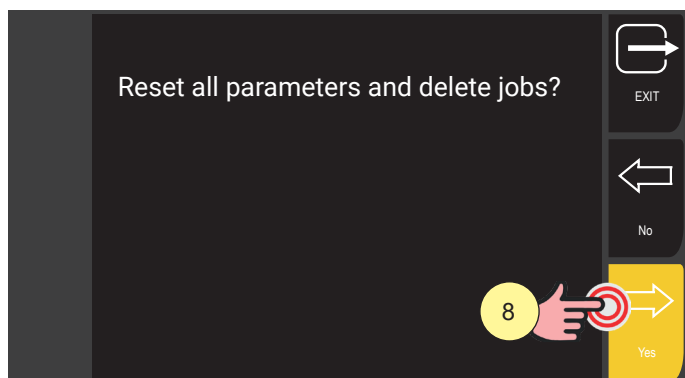

8. Press the encoder key or the [YES] key to confirm.

Press the [NO] key to go back to the previous screen.
Press the [EXIT] key to go back to the main screen.

10.3 RESET DISPLAY SETTINGS

The reset display settings procedure restores the default display settings. The default language (English) is reset, the shortcut keys are reset, the parameter display setup is returned to the default.

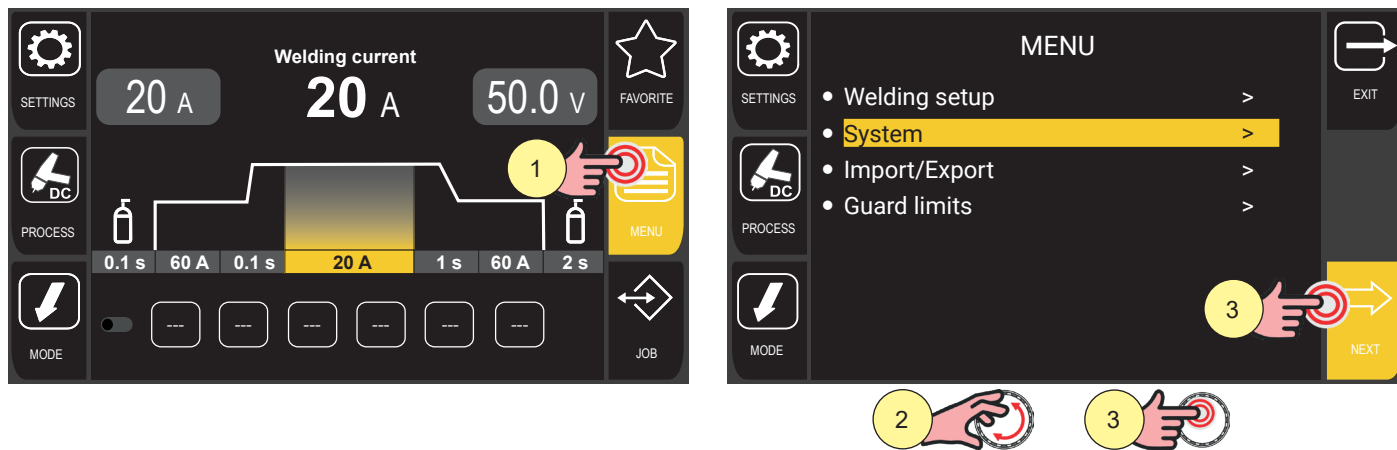

1. Press the [MENU] key.
2. Turn the encoder to select the desired setting.
Select the following path: System>
3. Press the encoder key or the [NEXT] key to confirm.

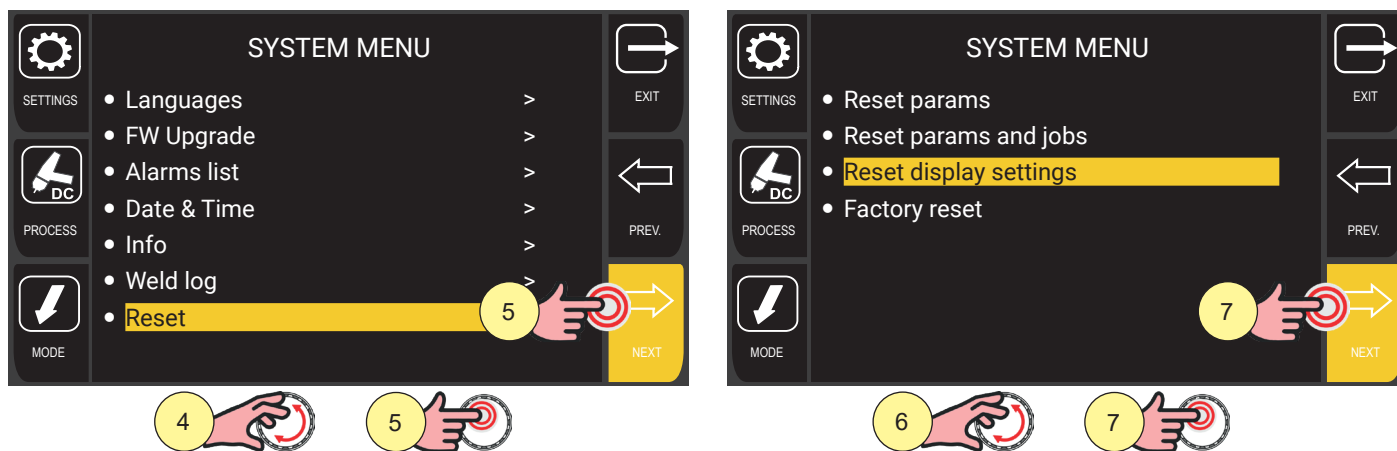

4. Turn the encoder to select the desired setting.
Select the following path: Reset>
5. Press the encoder key or the [NEXT] key to confirm.
6. Turn the encoder to select the desired setting.
Select the following path: Reset display settings
7. Press the encoder key or the [NEXT] key to confirm.

ENGLISH

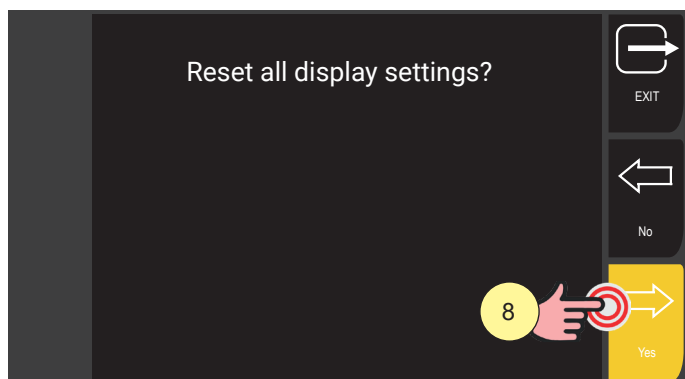

8. Press the encoder key or the [YES] key to confirm.

Press the [NO] key to go back to the previous screen.
Press the [EXIT] key to go back to the main screen.

10.4 FACTORY RESET

The factory reset procedure involves the full reset of the default values, parameters and memory settings set at the factory.

All memory locations will be reset and hence all your personal welding settings will be lost!
Only the settings relating to date and time remain saved.

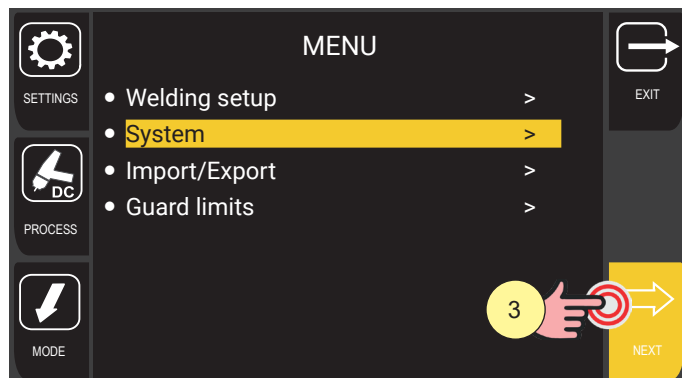
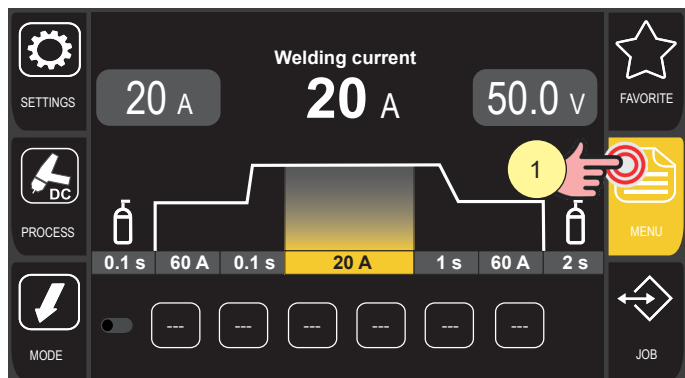

1. Press the [MENU] key.
2. Turn the encoder to select the desired setting.
Select the following path: System>
3. Press the encoder key or the [NEXT] key to confirm.

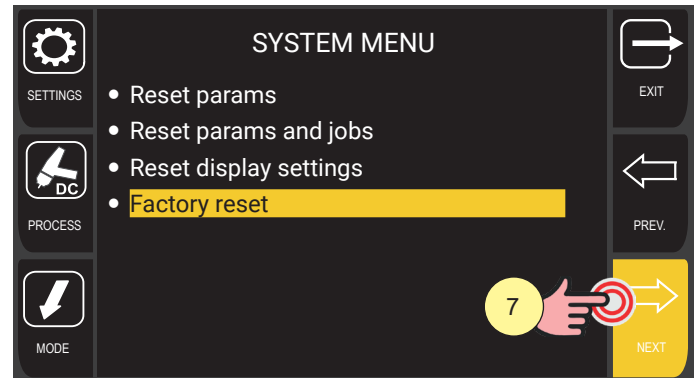
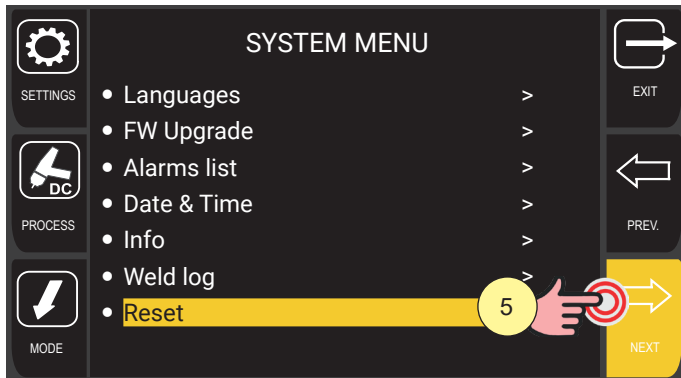

4. Turn the encoder to select the desired setting.
Select the following path: Reset>
5. Press the encoder key or the [NEXT] key to confirm.
6. Turn the encoder to select the desired setting.
Select the following path: Factory reset
7. Press the encoder key or the [NEXT] key to confirm.

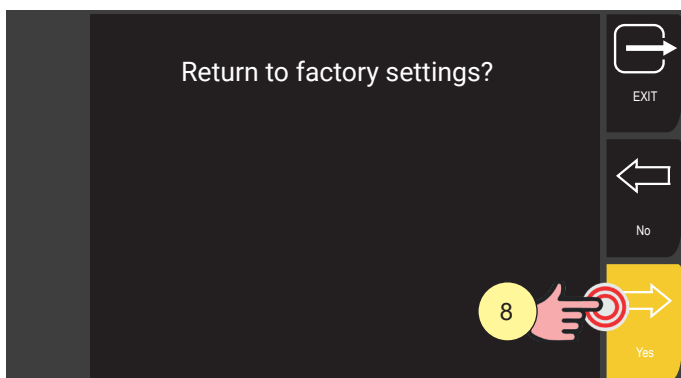

8. Press the encoder key or the [YES] key to confirm.

Press the [NO] key to go back to the previous screen.
Press the [EXIT] key to go back to the main screen.

11 ALARMS MANAGEMENT

This function is available when welding mode is not active.

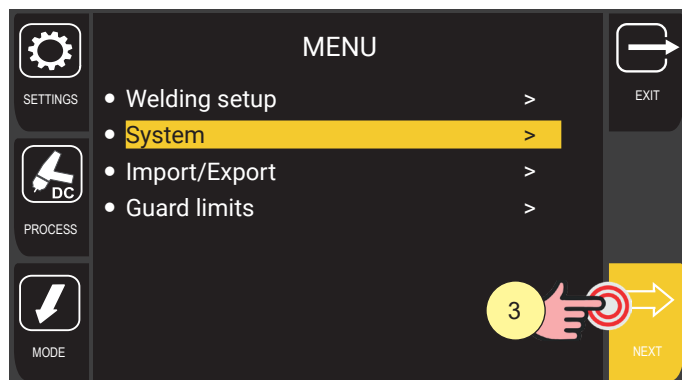
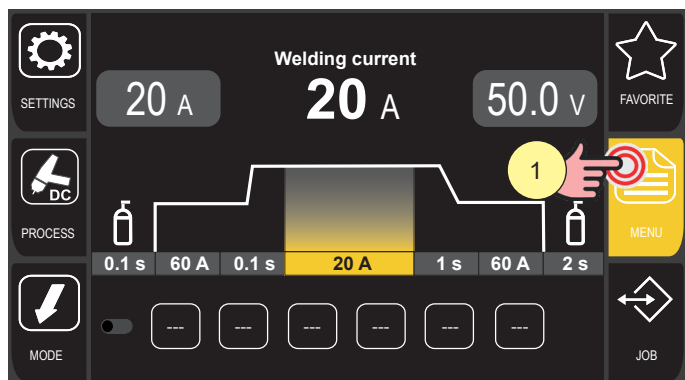

1. Press the [MENU] key.
2. Turn the encoder to select the desired setting.
Select the following path: System>
3. Press the encoder key or the [NEXT] key to confirm.

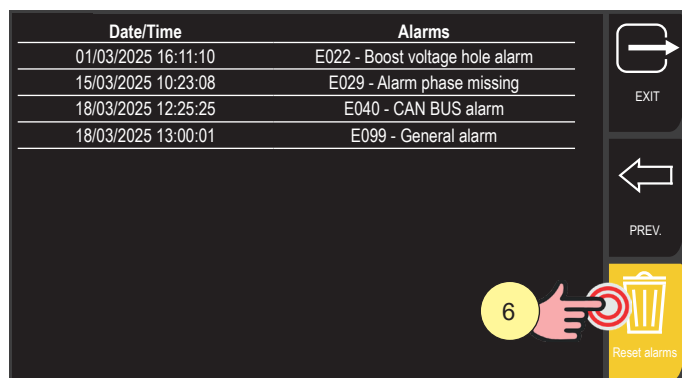
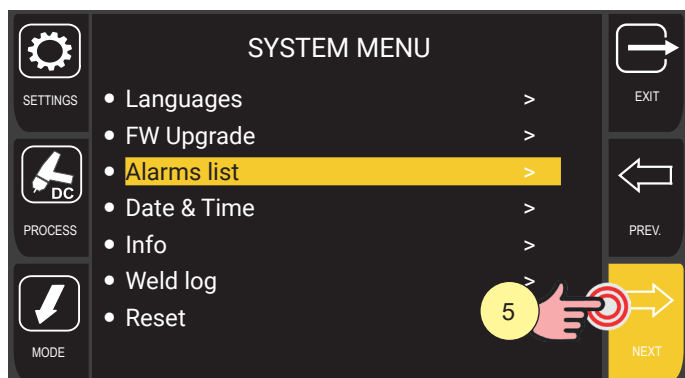

4. Turn the encoder to select the desired setting.
Select the following path: Alarms list>
5. Press the encoder key or the [NEXT] key to confirm.
6. Turn the encoder to select the desired setting.
The list of stored alarms is displayed.
7. Press the [RESET ALARMS] key to delete the list.

When an alarm condition occurs, all functions are disabled, except for:

- cooling fan
- cooling unit (if active)

11.1 ALARMS LIST

E02: NTC DISCONNECTED ALARM

- ▶ Indicates the information interruption between the NTC and the control system.
- ▶ Solution:
 - The intervention of qualified technical personnel is required for repairs/maintenance.

E04: VOUT DISCONNECTED ALARM

- ▶ Indicates that there is a short circuit between the (+) and (-) welding sockets.
- ▶ Solution:
 - Check that the welding torch is not resting on the piece to be welded connected to the ground.
 - Check that when the generator is switched on there is no short circuit between the sockets (the voltage must be greater than/equal to U_r).
 - If the problem persists, qualified technical personnel are required for repair/maintenance.

E05: WELD TORCH BUTTON PRESSED ALARM

- ▶ Indicates that when the generator was switched on, a short circuit was detected on the input of the torch trigger.
- ▶ Solution:
 - Make sure that the torch trigger is not pressed, jammed, or short circuiting.
 - Check that the torch and torch connector are intact.
 - When the problem ceases, the current generator will reset automatically.

E06: MISSING PROCESS ALARM

- ▶ An attempt is being made to call up a welding mode/process that is not available (also via Job loading). This happens when jobs have been imported from another generator.
- ▶ Solution:
 - Change the welding mode/process.
 - Select a different job.
 - Delete the incompatible job.

E07: MISSING PROGRAM ALARM

- ▶ The synergy/welding program is missing in the receiving unit.
- ▶ Solution:
 - Load the welding program in the generator
 - Select a different job.
 - Delete the incompatible job.

E08: JOB PARAMETERS NOT RECOGNISED ALARM

- ▶ The Job being loaded is not present in the memory and some parameters / display functions are missing in the receiving generator.
- ▶ Solution:
 - Select a different job.
 - Delete the incompatible job.

ENGLISH

E09: CURRENT JOB OUT OF RANGE ALARM

- ▶ The Job being loaded was saved with a current higher than the maximum current of the receiving unit.
- ▶ Solution:
 - Select a different job.
 - Delete the incompatible job.

E11: JOB WITH PARAMETER ABSENT ALARM

- ▶ The imported job has parameters that are not present in the receiving machine, i.e. the job was created with a previous firmware version not compatible with a more recent version.
- ▶ Solution:
 - Update the generator firmware.
 - Import the job again.

E26: ALARM GROUND CURRENT

- ▶ Current is re-circulated on the ground circuit.
- ▶ Solution:
 - Make sure that the welding circuit is not connected to the grounding system and that the machine's metal frame is not in contact with the workpiece.
 - If the problem persists, qualified technical personnel are required for repair/maintenance.

E27: POWER SUPPLY UNDERVOLTAGE ALARM

- ▶ Supply voltage low.
- ▶ Solution:
 - Check that the mains power supply does not fall below the minimum allowed values.

E28: POWER SUPPLY OVERVOLTAGE ALARM

- ▶ High supply voltage.
- ▶ Solution:
 - Check that the mains power supply does not exceed the maximum allowed values.

E29: ALARM PHASE MISSING

- ▶ Lack of a phase.
- ▶ Solution:
 - Check that all three phases come from the mains.
 - Check the integrity of the line fuses on the power supply panel.
 - If the problem persists, qualified technical personnel are required for repair/maintenance.

E30: PRIMARY OVERCURRENT ALARM

- ▶ Exceeding the current threshold at the primary.
- ▶ Solution:
 - The welding currents are at the limit of the maximum threshold: lower the welding parameters.
 - Check the stability of the power supply line.
 - Check the correct sizing of any power extension cables.
 - Check whether the issue only occurs with specific welding processes (MIG/MAG, TIG, MMA).
 - If the problem persists, qualified technical personnel are required for repair/maintenance.

E31: INVERTER THERMAL ALARM

- ▶ It indicates the intervention of the thermal protection due to overtemperature of the current generator.
- ▶ Solution:
 - Leave the equipment running so that the overheated components cool as rapidly as possible. When the problem is solved, the current generator will reset automatically.
 - Check the correct operation of the fans.
 - Make sure that the power required by the welding process is lower than the maximum rated power output.
 - Check that the operating conditions are in compliance with the current generator data plate specifications.
 - Check for the presence of adequate air circulation around the current generator.

E32: SECONDARY THERMAL ALARM

- ▶ It indicates the intervention of the thermal protection due to overtemperature of the current generator.
- ▶ Solution:
 - Leave the equipment running so that the overheated components cool as rapidly as possible. When the problem is solved, the current generator will reset automatically.
 - Check the correct operation of the fans.
 - Make sure that the power required by the welding process is lower than the maximum rated power output.
 - Check that the operating conditions are in compliance with the current generator data plate specifications.
 - Check for the presence of adequate air circulation around the current generator.

E33: GENERIC THERMAL ALARM

- ▶ It indicates the intervention of the thermal protection due to overtemperature of the current generator.
- ▶ Solution:
 - Leave the equipment running so that the overheated components cool as rapidly as possible. When the problem is solved, the current generator will reset automatically.
 - Check the correct operation of the fans.
 - Make sure that the power required by the welding process is lower than the maximum rated power output.
 - Check that the operating conditions are in compliance with the current generator data plate specifications.
 - Check for the presence of adequate air circulation around the current generator.

ENGLISH

E37: SECONDARY OVERCURRENT ALARM

- ▶ The I_{\max} threshold has been exceeded (i.e. the maximum current that can be delivered by the generator).
- ▶ Solution:
 - The welding currents are at the limit of the maximum threshold: lower the welding parameters.
 - If the problem persists, qualified technical personnel are required for repair/maintenance.

E40: CANBUS ALARM

- ▶ No communication between the devices connected in the CAN line.
- ▶ Solution:
 - Check the connection of the cable bundle between the generator and the wire feeder
 - If the problem persists, qualified technical personnel are required for repair/maintenance.

E49: DATA LOSS ALARM

- ▶ Incorrect data reading from EEPROM memory
- ▶ Solution:
 - The intervention of qualified technical personnel is required for repairs/maintenance.

E50: COOLING UNIT ALARM

- ▶ Indicates a lack of coolant circulation in the torch cooling circuit.
- ▶ Solution:
 - Check that the connection to the cooling unit is correct.
 - Check that the O/I switch is in the "I" position and that it lights up when the pump is running.
 - Check that the cooling liquid is present in the cooling unit.
 - Check that the pump flows the liquid (presence of external by-pass)
 - Check that the cooling circuit is liquid tight, notably the torch hoses, the fuse and the internal connections of the cooling unit.
 - If the problem persists, qualified technical personnel are required for repair/maintenance.

E58: INTERNAL POWER ALARM

- ▶ Indicates an anomaly in the internal auxiliary power supplies.
- ▶ Solution:
 - Turn the generator off and on again.
 - If the problem persists, qualified technical personnel are required for repair/maintenance.

E65: HIGH INDUCTIVE LOAD ALARM

► Indicates that the generator has entered protection mode due to high output load or improper welding settings (only for generators with AC/DC welding functions). Welding cannot continue.

► Solution:

- Improve the welding circuit: check the quality of the ground path by reducing the length and/or increasing the section of the cable.
- Reduce the welding current.
- Reduce the AC inversion frequency.
- If the problem persists, qualified technical personnel are required for repair/maintenance.

E81: ALARM HIGH VOLTAGE LIMIT EXCEEDED

► Alarm generated only if the specific option has been activated in the “GUARD LIMITS” menu. The welding process has been interrupted.

► Solution:

- Check that the guard limit parameter is correct according to the welding parameters set.
- Check that there are no welding problems related to the consumable, gas used, welding position, mass, torch, wire drive, special active functions.

E82: ALARM LOW CURRENT LIMIT EXCEEDED

► Alarm generated only if the specific option has been activated in the “GUARD LIMITS” menu. The welding process has been interrupted.

► Solution:

- Check that the guard limit parameter is correct according to the welding parameters set.
- Check that there are no welding problems related to the consumable, gas used, welding position, mass, torch, wire drive, special active functions.

E83: ALARM HIGH VOLTAGE LIMIT EXCEEDED

► Alarm generated only if the specific option has been activated in the “GUARD LIMITS” menu. The welding process has been interrupted.

► Solution:

- Check that the guard limit parameter is correct according to the welding parameters set.
- Check that there are no welding problems related to the consumable, gas used, welding position, mass, torch, wire drive, special active functions.

E84: ALARM LOW VOLTAGE LIMIT EXCEEDED

► Alarm generated only if the specific option has been activated in the “GUARD LIMITS” menu. The welding process has been interrupted.

► Solution:

- Check that the guard limit parameter is correct according to the welding parameters set.
- Check that there are no welding problems related to the consumable, gas used, welding position, mass, torch, wire drive, special active functions.

ENGLISH

E87: ALARM UPPER GAS LIMIT EXCEEDED

▶ Alarm generated only if the specific option has been activated in the “GUARD LIMITS” menu (only for machines equipped with a GAS SENSOR kit). The welding process has been interrupted.

▶ Solution:

- Check the gas flow rate in the system connected to the device.
- If the problem persists, qualified technical personnel are required for repair/maintenance.

E88: ALARM LOW GAS FLOW LIMIT EXCEEDED

▶ Alarm generated only if the specific option has been activated in the “GUARD LIMITS” menu (only for machines equipped with a GAS SENSOR kit). The welding process has been interrupted.

▶ Solution:

- Check the gas flow rate in the system connected to the device.
- If the problem persists, qualified technical personnel are required for repair/maintenance.

W81: WARNING UPPER CURRENT LIMIT EXCEEDED

▶ Alarm generated only if the specific option has been activated in the “GUARD LIMITS” menu. The welding process is continuing.

▶ Solution:

- Check that the guard limit parameter is correct according to the welding parameters set.
- Check that there are no welding problems related to the consumable, gas used, welding position, mass, torch, wire drive, special active functions.

W82: WARNING LOWER CURRENT LIMIT EXCEEDED

▶ Alarm generated only if the specific option has been activated in the “GUARD LIMITS” menu. The welding process is continuing.

▶ Solution:

- Check that the guard limit parameter is correct according to the welding parameters set.
- Check that there are no welding problems related to the consumable, gas used, welding position, mass, torch, wire drive, special active functions.

W83: WARNING UPPER VOLTAGE LIMIT EXCEEDED

▶ Alarm generated only if the specific option has been activated in the “GUARD LIMITS” menu. The welding process is continuing.

▶ Solution:

- Check that the guard limit parameter is correct according to the welding parameters set.
- Check that there are no welding problems related to the consumable, gas used, welding position, mass, torch, wire drive, special active functions.

W84: WARNING LOWER VOLTAGE LIMIT EXCEEDED

▶ Alarm generated only if the specific option has been activated in the “GUARD LIMITS” menu. The welding process is continuing.

▶ Solution:

- Check that the guard limit parameter is correct according to the welding parameters set.
- Check that there are no welding problems related to the consumable, gas used, welding position, mass, torch, wire drive, special active functions.

W87: WARNING UPPER GAS LIMIT EXCEEDED

▶ Alarm generated only if the specific option has been activated in the “GUARD LIMITS” menu (only for machines equipped with a GAS SENSOR kit). The welding process is continuing.

▶ Solution:

- Check the gas flow rate in the system connected to the device.
- If the problem persists, qualified technical personnel are required for repair/maintenance.

W88: WARNING LOWER GAS LIMIT EXCEEDED

▶ Alarm generated only if the specific option has been activated in the “GUARD LIMITS” menu (only for machines equipped with a GAS SENSOR kit). The welding process is continuing.

▶ Solution:

- Check the gas flow rate in the system connected to the device.
- If the problem persists, qualified technical personnel are required for repair/maintenance.

E99: GENERAL ALARM

▶ Indicates the non-recognition of the generator.

▶ Solution:

- Check the integrity of the connections between generator and remote controls (wire feed trolleys, remotes, other devices).
- If the problem persists, qualified technical personnel are required for repair/maintenance.

ENGLISH

12 SYSTEM INFO

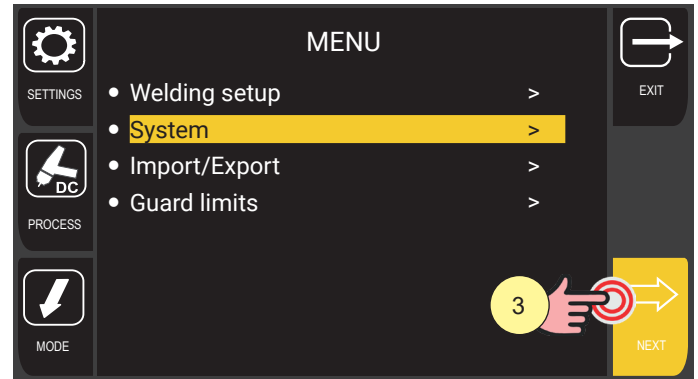
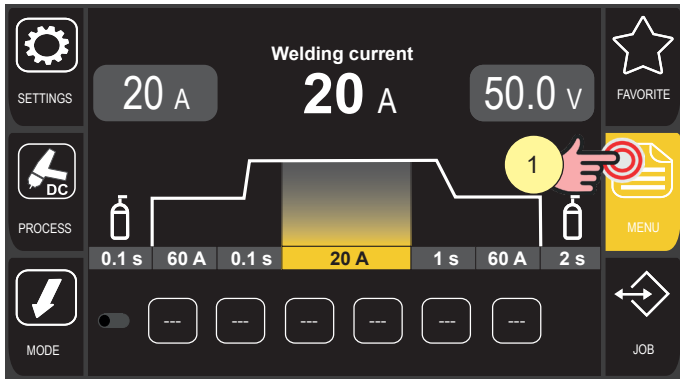

1. Press the [MENU] key.
2. Turn the encoder to select the desired setting.
Select the following path: System>
3. Press the encoder key or the [NEXT] key to confirm.

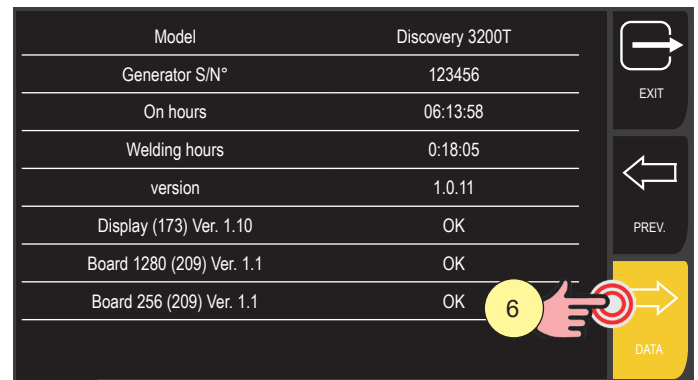
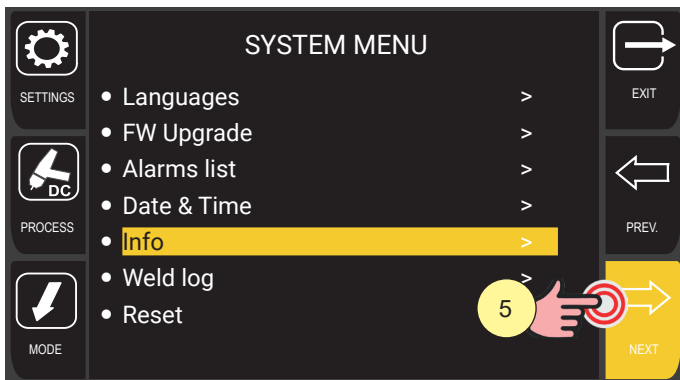

4. Turn the encoder to select the desired setting.
Select the following path: Info>
5. Press the encoder key or the [NEXT] key to confirm.

The screen shows:

- generator model
- generator serial number
- number of hours of machine on
- number of hours welding

After 10 seconds, the screen shows:

- the list of boards with microcontrollers and the respective firmware version





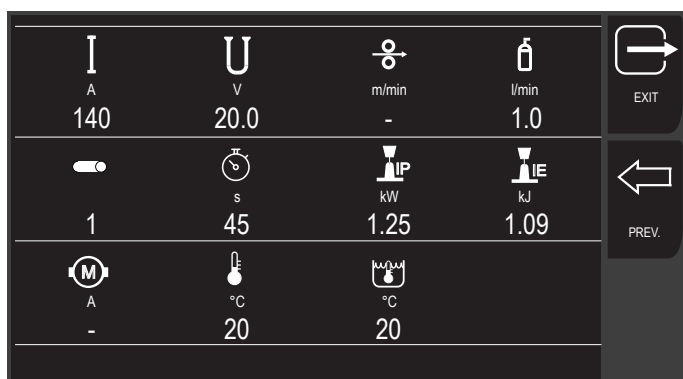

6. Press the [DATA] key.

This gives access to the screen that shows the system data in real time.



<p>I A 140</p>	<p>Instantaneous value of the welding current.</p>
<p>U V 20.0</p>	<p>Instantaneous value of the welding voltage.</p>
<p>v m/min 10.4</p>	<p>Instantaneous value of the wire speed.</p>
<p>l/min 1.0</p>	<p>Gas flow value in litres/minute (only if the sensor is present).</p>
<p>1</p>	<p>Progressive number of the weld bead from the moment the generator is switched on (starts from 1 each time it is switched on).</p>

ENGLISH

 s 45	<p>Welding time of the single bead.</p>
 kW 1.25	<p>Instantaneous welding arc power in kW. INSTANT POWER: Average value of the instantaneous power that is given by the product of VOLTAGE by CURRENT sampled every 100 micro seconds.</p>
 kJ 1.09	<p>Welding arc energy in kJ. INSTANT ENERGY: Average value of the instantaneous power that is given by the product of VOLTAGE by CURRENT IN THE TIME UNIT sampled every 100 micro seconds.</p>
 A 2.3	<p>Wire drive motor current value. Measures the current drawn by the wire drive motor during welding. Excessive values mean drive problems (jammed wire, dirty sheath, worn or clogged current tube, etc.)</p>
 C° 20.0	<p>Heat sink temperature in the generator.</p>
 C° 20.0	<p>Cooling unit water temperature.</p>

Press the  [PREV.] key to go back to the previous screen.

Press the  [EXIT] key to go back to the main screen.

13 WELD LOG

The screen displays the welding data of the last 500 welds carried out.
Data can be exported as a CSV file to a USB pen drive.

13.1 WELD LOG DISPLAY

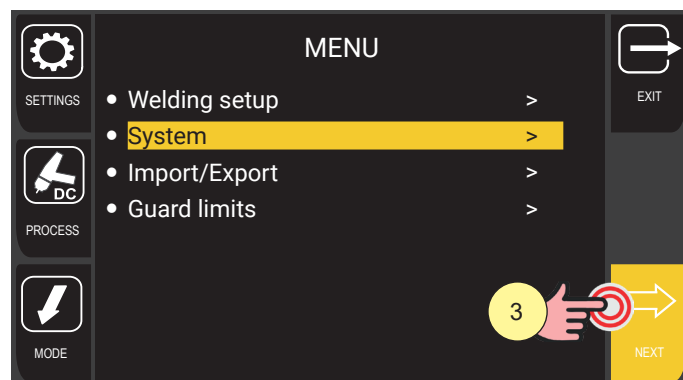
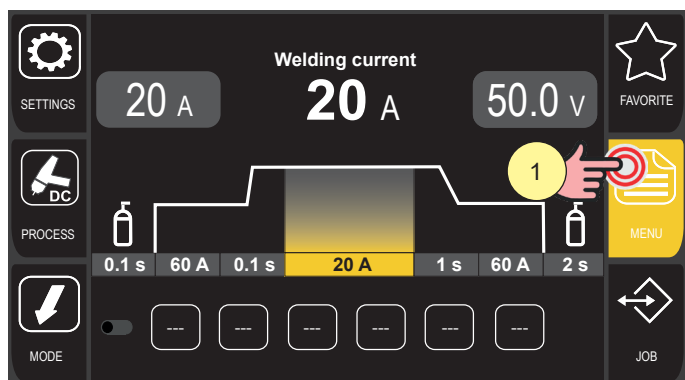

1. Press the [MENU] key.
2. Turn the encoder to select the desired setting.
Select the following path: System>
3. Press the encoder key or the [NEXT] key to confirm.

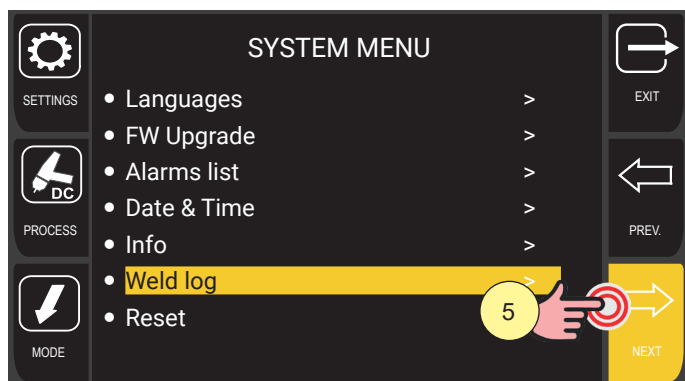

	N.	yymmmmaa	hhmmss	s	A	V	m/min	N.	kJ
4	2025-04-13	09:58:24	2.4	60	26.2	-	0	0.1	
3	2025-04-13	09:58:10	3.5	69	18.2	-	0	0.1	
2	2025-04-13	09:57:50	5.3	42	20.7	-	0	0.1	
1	2025-04-13	09:57:15	4.6	65	19.2	-	1	0.3	



4. Turn the encoder to select the desired setting.
Select the following path: Weld log>
5. Press the encoder key or the [NEXT] key to confirm.

The screen shows:

- progressive number of the weld bead from the moment the generator is switched on (starts from 1 each time it is switched on)
- date (day/month/year)
- welding start time (hours/minutes/seconds)
- welding time in seconds (single bead)
- average welding current (bead carried out)
- average welding voltage (bead carried out)
- average wire speed

ENGLISH

- job number (if loaded)
- instantaneous arc energy in kJ

If GUARD LIMITS are active, when an alarm/warning condition occurs, the box corresponding to the controlled parameter changes colour:

- set alarm value limit exceeded (red box + symbol ↓ for lower limit or symbol ↑ for upper limit)
- set warning limit exceeded (yellow box + symbol ↓ for lower limit or symbol ↑ for upper limit)

	N.	yymmaa	hhmmss	s	A	V	m/min	N.	kJ	
4	2025-04-13	09:58:24	2.4	60	26.2	-	0	0.1		EXIT
3	2025-04-13	09:58:10	3.5	69 ↑	18.2	-	0	0.1		PREV.
2	2025-04-13	09:57:50	5.3	42 ↓	20.7	-	0	0.1		EXPORT
1	2025-04-13	09:57:15	4.6	65	19.2	-	1	0.3		

13.2 WELD LOG EXPORT

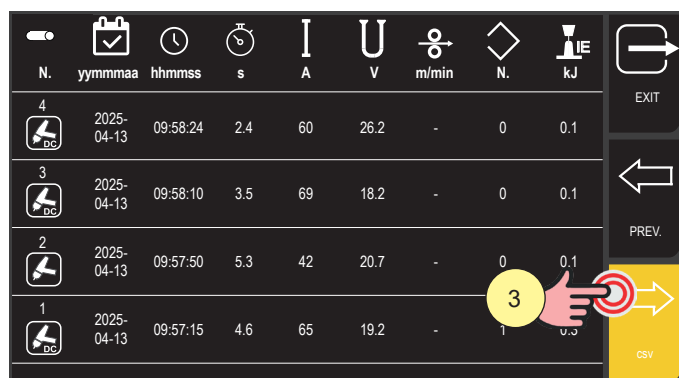
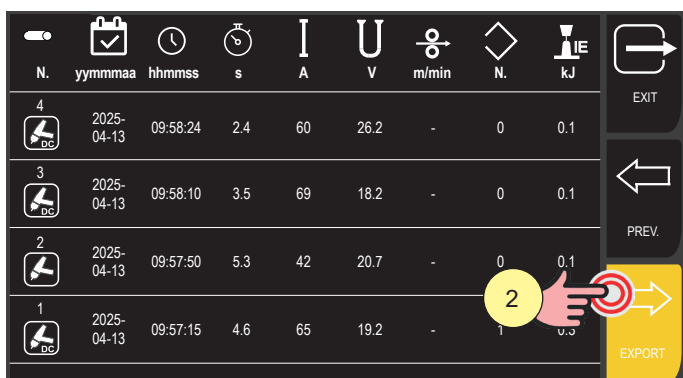
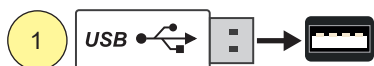

1. Please insert the USB pen drive into the dedicated port.
2. Press the [EXPORT] key.
3. Press the [csv] key.

Press the [PREV.] key to go back to the previous screen.

Press the [EXIT] key to go back to the main screen.

The data is saved in .CSV format, which can be imported, for example, using Excel.

	A	B	C	D	E	F	G	H	I	J	K	L	M
1	Type : weldlogs												
2	Date : 2021/04/01 12:49:43												
3	Machine : 257												
4	NumSer : 180027												
5	Seam	Date	Start	Arc time	Current	Voltage	Speed	Power	Energy	Gas	Job	Alarm	
6				s	A	V	m/min	W	kJ	l/min			
7	6	16/03/2021	10:01:49	5,6	100	20,1	2,3	1435	8	0	0	0	
8	5	16/03/2021	10:00:40	10,2	104	16,2	2,3	1499	15,3	0	0	0	
9	4	16/03/2021	09:57:49	5,6	110	15,2	2,4	895	5	0	0	0	
10	3	16/03/2021	09:52:22	3,4	133	15,8	2,3	887	3	0	0	0	
11	2	16/03/2021	09:27:07	6,8	116	17	2,3	1627	11,1	0	0	0	
12	1	16/03/2021	09:25:56	22,8	114	15,7	2,3	1616	36,8	0	0	0	
13	3	15/03/2021	14:44:55	1,6	110	21,1	2,2	1430	2,3	0	0	0	
14	2	15/03/2021	14:43:58	1,4	114	18,1	2,1	1560	2,2	0	0	0	
15	1	15/03/2021	14:43:01	4,2	113	16,4	2,2	1571	6,6	0	0	0	
16	2	15/03/2021	14:29:50	5,8	113	15,3	2,2	1539	8,9	0	0	0	
17	1	15/03/2021	14:24:43	4,2	107	16,6	2,3	1434	6	0	0	0	
18	3	15/03/2021	14:13:52	1,2	99	22,7	2,1	1407	1,7	0	0	0	
19	2	15/03/2021	14:13:00	2	104	20,7	2,3	1386	2,8	0	0	0	
20	1	15/03/2021	14:11:14	3,2	100	21,7	411,7	1311	4,2	0	0	0	
21	4	15/03/2021	13:52:07	2,6	107	18	2,2	1492	3,9	0	0	0	
22	3	15/03/2021	13:50:49	3	113	16,7	2,3	1438	4,3	0	0	0	
23	2	15/03/2021	13:49:49	3,4	107	18	2,3	1443	4,9	0	0	0	
24	1	15/03/2021	13:48:04	5,8	106	18,2	2,3	1390	8,1	0	0	0	
25	2	15/03/2021	13:35:37	4,6	117	14,8	2,3	1400	6,4	0	0	0	
26	1	15/03/2021	13:07:38	5,8	111	16,2	2,3	1332	7,7	0	0	0	

ENGLISH

14 SERVICE

The service menu is used to activate additional functions; the password is not provided to the end user as the activation of these functions is reserved for qualified technical personnel authorised by the manufacturer for maintenance and troubleshooting of the equipment.

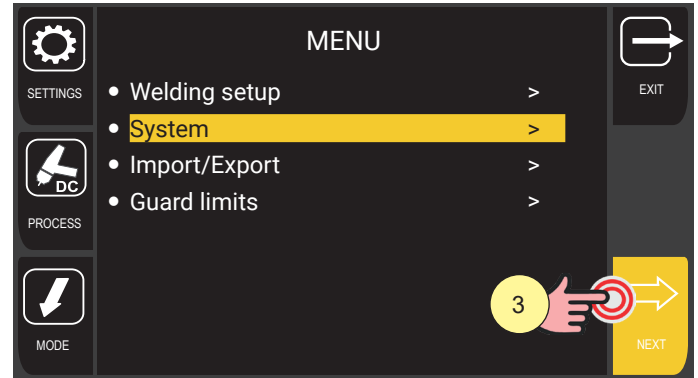
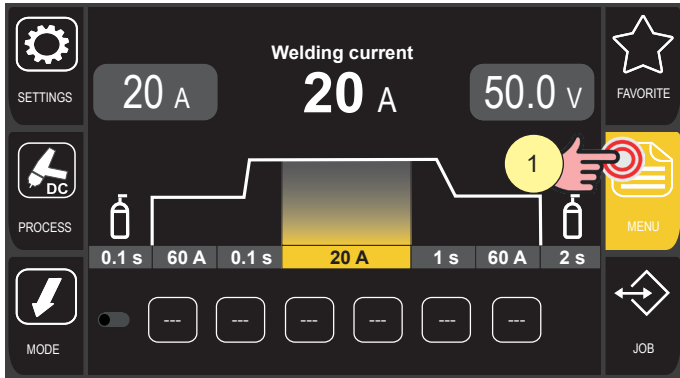

1. Press the [MENU] key.
2. Turn the encoder to select the desired setting.
Select the following path: System>
3. Press the encoder key or the [NEXT] key to confirm.

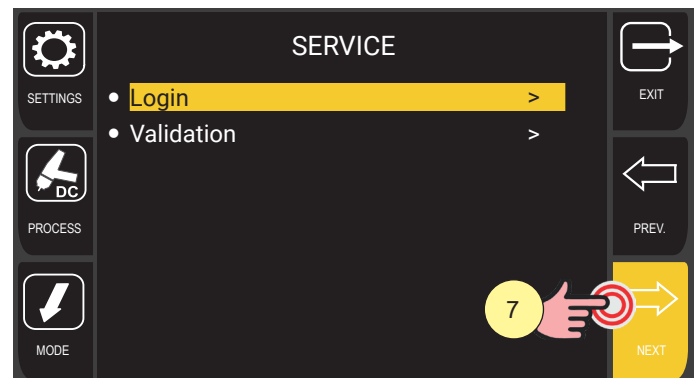
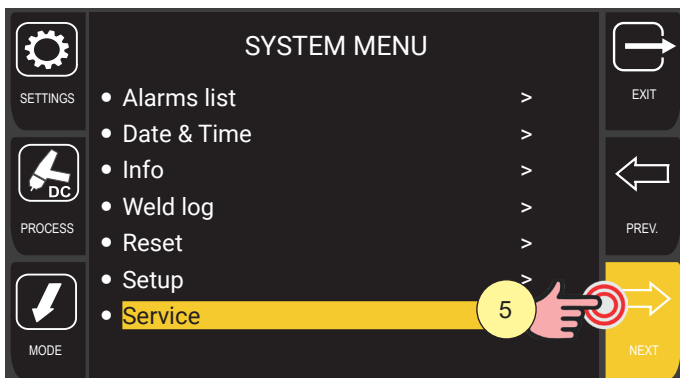

4. Turn the encoder to select the desired setting.
Select the following path: Service>
5. Press the encoder key or the [NEXT] key to confirm.
6. Turn the encoder to select the desired setting.
Select the following path: Login>
7. Press the encoder key or the [NEXT] key to confirm.

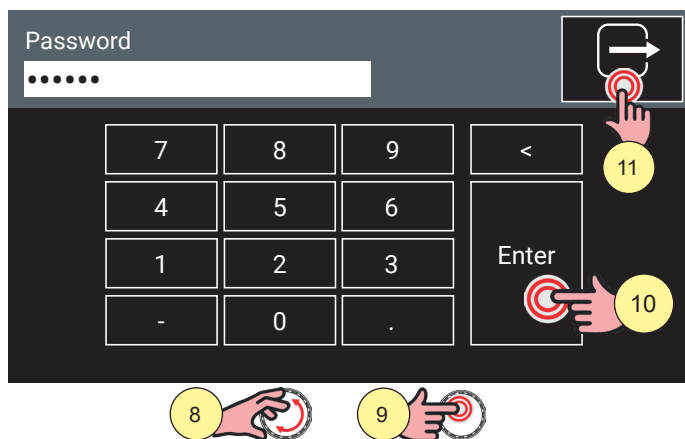

8. Turn the encoder to select the number on the keyboard.
9. Press the encoder key to confirm the selection.

i Information The panel is of the touch screen type; settings can be made both by means of the mechanical keys and by touching the icons that appear on the screen.

10. Press the [ENTER] key to confirm the password.
11. Press the [EXIT] key to exit the screen.

ENGLISH

15 VALIDATION

This section is used to carry out verification tests according to current regulations. Please refer to the dedicated manual for operating procedures.

Below is the procedure to be followed to access the VALIDATION menu.

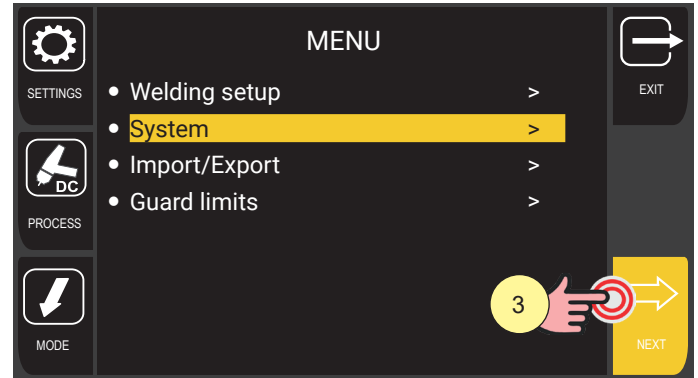
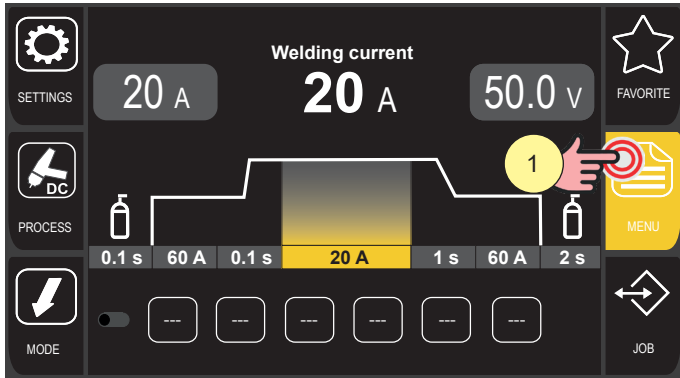

1. Press the [MENU] key.
2. Turn the encoder to select the desired setting.
Select the following path: System>
3. Press the encoder key or the [NEXT] key to confirm.

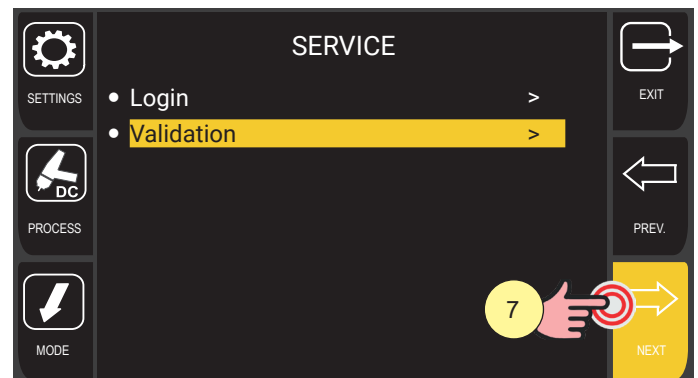
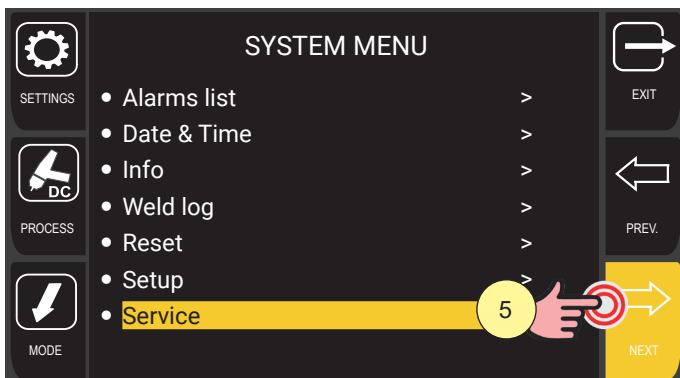

4. Turn the encoder to select the desired setting.
Select the following path: Service>
5. Press the encoder key or the [NEXT] key to confirm.
6. Turn the encoder to select the desired setting.
Select the following path: Validation>
7. Press the encoder key or the [NEXT] key to confirm.

The following options are available:



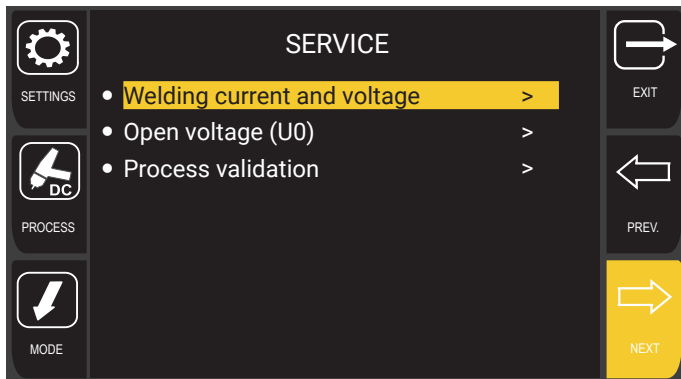

- Welding current and voltage
- No-load voltage
- Process Validation





i Information See the specific manual for the validation operating procedures.

ENGLISH

16 TECHNICAL DATA



Directives applied	Waste electrical and electronic equipment (WEEE)
	Electromagnetic compatibility (EMC)
	Low voltage (LVD)
	Restriction of the use of certain hazardous substances (RoHS)
	Eco Design of energy-related products
Construction standards	EN 60974-1; EN 60974-5; EN 60974-10 Class A
Conformity markings	 Equipment compliant with European directives in force
	 Equipment compliant with current UK regulations
	 Equipment suitable in an environment with increased hazard of electric shock
	 Equipment compliant with WEEE directive
	 Equipment compliant with RoHS directive

16.1 DISCOVERY 3200T



Supply voltage	3 x 400 Va.c. ± 15% 50/60 Hz			
Network protection	20 A delayed			
Zmax	TBD			
Dimensions (W x H x D)	293 mm x 466 mm x 722 mm			
Weight	35.2 kg			
Insulation class	H			
Protection rating	IP23S			
Cooling	AF: Forced air cooling (with fan)			
Maximum gas pressure	0.5 MPa (5 bar)			
Welding mode		MMA	TIG	MIG
Static characteristic		 Falling characteristic	 Falling characteristic	 Flat characteristic
Current and voltage regulation range		10 A - 20.4 V 320 A - 32.8 V	3 A - 10.1 V 320 A - 22.8 V	10 A - 14.5 V 320 A - 30.0 V
Welding current – Working voltage	40% (40 °C)	-	-	-
	60% (40 °C)	320 A - 32.8 V	320 A - 22.8 V	320 A - 30.0 V
	100% (40 °C)	260 A - 30.4 V	260 A - 20.4 V	260 A - 27.0 V
Maximum power absorbed	40% (40 °C)	-	-	-
	60% (40 °C)	12.9 kVA - 12.2 kW	9.4 kVA - 8.8 kW	12.0 kVA - 11.2 kW
	100% (40 °C)	9.8 kVA - 9.2 kW	7.0 kVA - 6.4 kW	8.7 kVA - 8.2 kW
Maximum current absorbed	40% (40 °C)	-	-	-
	60% (40 °C)	18.7A	13.7A	17.3A
	100% (40 °C)	14.2A	10.2A	12.6A
Actual current absorbed	40% (40 °C)	-	-	-
	60% (40 °C)	14.5A	10.6A	13.4A
	100% (40 °C)	14.2A	10.2A	12.6A
Peak voltage HF (Up)	9.1 kV			
Open voltage (U0)	66.0 V			
Reduced open voltage (Ur)	6.6 V			
Energy source efficiency	Efficiency (320 A - 32,8 V): 85%			
	Energy consumption in no-load conditions (U1 = 400 Va.c.): TBD			
Critical raw materials	According to the information provided by our suppliers, this product does not contain any critical raw materials in quantities greater than 1 g per component.			

ENGLISH

16.2 DISCOVERY 4000T

Supply voltage	3 x 400 Va.c. ± 15% 50/60 Hz			
Network protection	32 A delayed			
Zmax	TBD			
Dimensions (W x H x D)	293 mm x 466 mm x 722 mm			
Weight	35.5 kg			
Insulation class	H			
Protection rating	IP23S			
Cooling	AF: Forced air cooling (with fan)			
Maximum gas pressure	0.5 MPa (5 bar)			
Welding mode		MMA	TIG	MIG
Static characteristic		 Falling characteristic	 Falling characteristic	 Flat characteristic
Current and voltage regulation range		10 A - 20.4 V 400 A - 36.0 V	5A - 10.2 V 400 A - 26.0 V	10 A - 14.5 V 400 A - 34.0 V
Welding current – Working voltage	40% (40 °C)	-	-	-
	60% (40 °C)	-	-	-
	100% (40 °C)	400 A - 36.0 V	400 A - 26.0 V	400 A - 34.0 V
Maximum power absorbed	40% (40 °C)	-	-	-
	60% (40 °C)	-	-	-
	100% (40 °C)	17.3 kVA - 16.5 kW	12.9 kVA - 12.4 kW	16.5 kVA - 15.7 kW
Maximum current absorbed	40% (40 °C)	-	-	-
	60% (40 °C)	-	-	-
	100% (40 °C)	25.0A	18.6A	23.9A
Actual current absorbed	40% (40 °C)	-	-	-
	60% (40 °C)	-	-	-
	100% (40 °C)	25.0A	18.6A	23.9A
Peak voltage HF (Up)	9.1 kV			
Open voltage (U0)	66.0 V			
Reduced open voltage (Ur)	6.6 V			
Energy source efficiency	Efficiency (400 A - 36,0 V): 86%			
	Energy consumption in no-load conditions (U1 = 400 Va.c.): TBD			
Critical raw materials	According to the information provided by our suppliers, this product does not contain any critical raw materials in quantities greater than 1 g per component.			

16.3 DISCOVERY 5000T

Supply voltage	3 x 400 Va.c. ± 15% 50/60 Hz			
Network protection	32 A delayed			
Zmax	TBD			
Dimensions (W x H x D)	293 mm x 466 mm x 722 mm			
Weight	35.5 kg			
Insulation class	H			
Protection rating	IP23S			
Cooling	AF: Forced air cooling (with fan)			
Maximum gas pressure	0.5 MPa (5 bar)			
Welding mode		MMA	TIG	MIG
Static characteristic		 Falling characteristic	 Falling characteristic	 Flat characteristic
Current and voltage regulation range		10 A - 20.4 V 500 A - 40.0 V	3 A - 10.1 V 500 A - 30.0 V	10 A - 14.5 V 500 A - 39.0 V
Welding current – Working voltage	40% (40 °C)	500 A - 40.0 V	500 A - 30.0 V	500 A - 39.0 V
	60% (40 °C)	450 A - 38.0 V	450 A - 28.0 V	450 A - 36.5 V
	100% (40 °C)	400 A - 36.0 V	400 A - 26.0 V	400 A - 34.0 V
Maximum power absorbed	40% (40 °C)	24.5 kVA - 23.1 kW	18.8 kVA - 17.8 kW	23.8 kVA - 22.6 kW
	60% (40 °C)	20.7 kVA - 19.7 kW	15.7 kVA - 15.0 kW	20.0 kVA - 19.0 kW
	100% (40 °C)	17.3 kVA - 16.5 kW	12.9 kVA - 12.4 kW	16.5 kVA - 15.7 kW
Maximum current absorbed	40% (40 °C)	35.4A	27.2A	34.4A
	60% (40 °C)	29.9A	22.7A	28.9A
	100% (40 °C)	25.0A	18.6A	23.9A
Actual current absorbed	40% (40 °C)	22.4A	17.2A	21.8A
	60% (40 °C)	23.2A	17.6A	22.4A
	100% (40 °C)	25.0A	18.6A	23.9A
Peak voltage HF (Up)	9.1 kV			
Open voltage (U0)	66.0 V			
Reduced open voltage (Ur)	6.6 V			
Energy source efficiency	Efficiency (500 A - 40,0 V): 86%			
	Energy consumption in no-load conditions (U1 = 400 Va.c.): TBD			
Critical raw materials	According to the information provided by our suppliers, this product does not contain any critical raw materials in quantities greater than 1 g per component.			

ENGLISH

16.4 DIMENSIONED DRAWINGS

Discovery 3200T - Discovery 4000T - Discovery 5000T

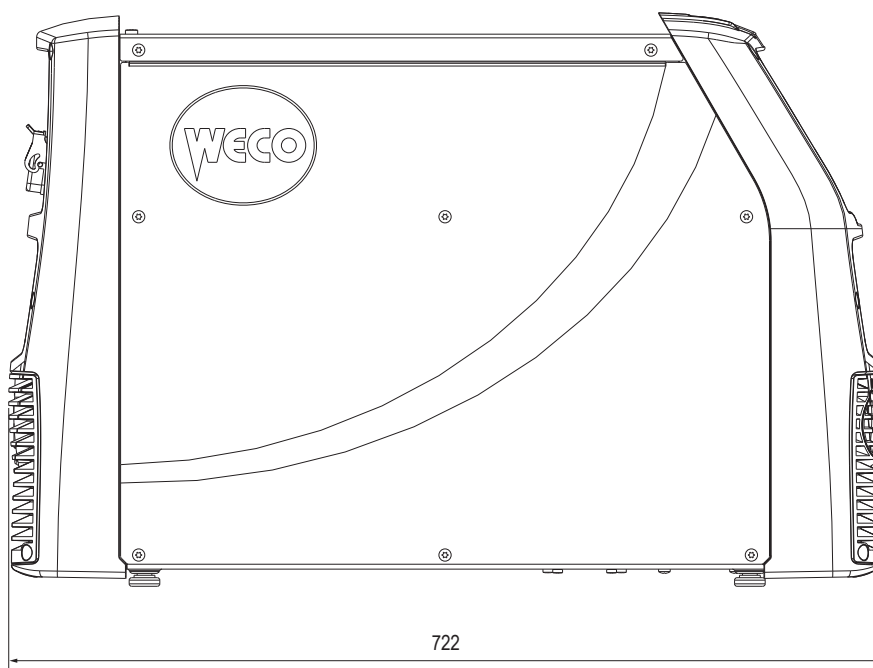
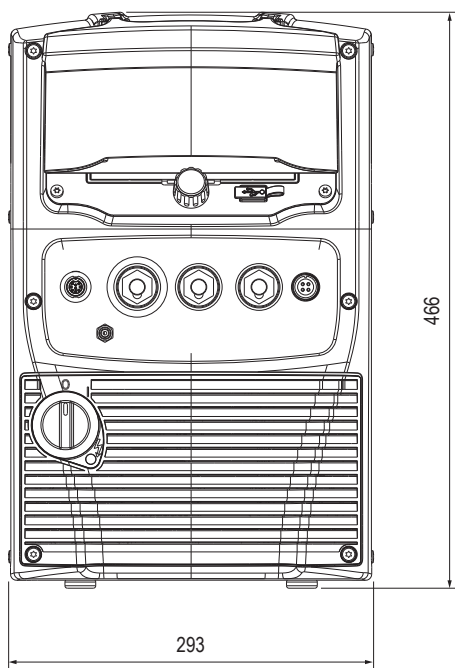



WELD THE WORLD

WECO srl
www.weco.it

006.0001.2510
26/03/2026 R0

