



WELD THE WORLD

# Discovery 150TP

## Instruction manual





WELD THE WORLD

**ENGLISH**

---



---

## INDEX

<b>1</b>	<b>INTRODUCTION</b> .....	<b>4</b>
1.1	INTRODUCTION.....	5
<b>2</b>	<b>INSTALLATION</b> .....	<b>5</b>
2.1	CONNECTIONS TO THE ELECTRICAL MAINS NETWORK.....	5
2.2	FRONT PANEL.....	6
2.3	REAR PANEL.....	6
2.4	PREPARING FOR MMA WELDING.....	7
2.5	PREPARING FOR TIG WELDING .....	8
<b>3</b>	<b>COMMISSIONING</b> .....	<b>9</b>
3.1	USER INTERFACE .....	9
3.2	WELDING PARAMETERS .....	10
<b>4</b>	<b>TECHNICAL DATA</b> .....	<b>11</b>
<b>5</b>	<b>SPARE PARTS</b> .....	<b>13</b>
<b>6</b>	<b>ELECTRICAL DIAGRAM</b> .....	<b>15</b>
6.1	DISCOVERY 150TP.....	15

**ENGLISH**

# 1 INTRODUCTION

 	<h2 style="text-align: center;">IMPORTANT!</h2>
<p><i>This handbook must be consigned to the user prior to installation and commissioning of the unit. Read the “General prescriptions for use” handbook supplied separately from this handbook before installing and commissioning the unit.</i></p> <p><i>The meaning of the symbols in this manual and the associated precautionary information are given in the “General prescriptions for use”.</i></p> <p><i>If the “General prescriptions for use” are not present, it is mandatory to request a replacement copy from the manufacturer or from your dealer.</i></p> <p><i>Retain these documents for future consultation.</i></p>	

## LEGEND

	<h3 style="text-align: center; color: white;">DANGER!</h3>
<p style="text-align: center;"><i>This pictogram warns of danger of death or serious injury.</i></p>	

	<h3 style="text-align: center; color: white;">WARNING!</h3>
<p style="text-align: center;"><i>This pictogram warns of a risk of injury or damage to property.</i></p>	

	<h3 style="text-align: center; color: black;">CAUTION!</h3>
<p style="text-align: center;"><i>This pictogram warns of a potentially hazardous situation.</i></p>	

	<h3 style="text-align: center;">INFORMATION</h3>
<p style="text-align: center;"><i>This pictogram gives important information concerning the execution of the relevant operations.</i></p>	

- ➡ This symbol identifies an action that occurs automatically as a result of a previous action.
- ① This symbol identifies additional information or a reference to a different section of the manual containing the associated information.
- § This symbol identifies a reference to a chapter of the manual.
- \*1 The symbol refers to the associated numbered note.

## NOTES

The figures in this manual are purely guideline and the images may contain differences with respect to the actual equipment to which they refer.

## 1.1 INTRODUCTION

Discovery 150TP is an advanced inverter power source characterized by a robust and reliable industrial construction.

It is recommended for MMA welding and TIG DC applications providing excellent arc characteristics. Discovery 150TP is ideal for operations on site like basic maintenance and building construction.

A built-in Total Protection Device saves the inverter components from overvoltage and makes the unit suitable for use with unstable power supply and motor-generators.

Factory optimized Hot Start, Arc Force and Anti Sticking allow an easy and excellent quality welding using electrodes up to 3.25 mm diameter.

In TIG DC, Pulse selection is included, making Discovery 150TP unique in its range.

Lift Start function guarantees arc ignition without damaging the tungsten electrode.

## 2 INSTALLATION



**DANGER!**  
**Lifting and positioning**

*Read the warnings highlighted by the following symbols in the "General prescriptions for use".*



### 2.1 CONNECTIONS TO THE ELECTRICAL MAINS NETWORK

The characteristics of the mains power supply to which the equipment shall be connected are given in the section entitled "4 TECHNICAL DATA" on page 11.

Connect/disconnect the various devices with the machine switched off.

ENGLISH

2.2 FRONT PANEL

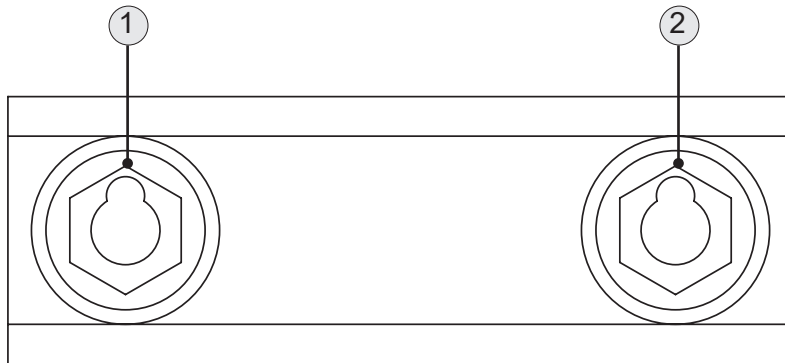

- Positive pole welding socket [Part. 1].
- Negative pole welding socket [Part. 2].

2.3 REAR PANEL

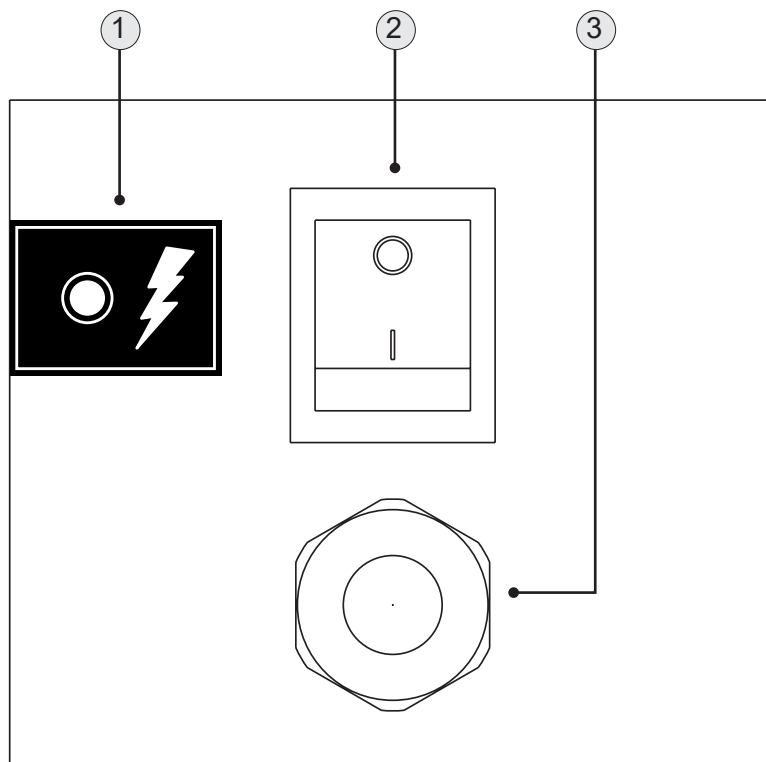

- Warning LED for overcut protection triggering. In case of over-voltage in the supply line, the supply to the power source is cut off. The overcut protection protects electronic parts of the machine against damage caused by voltage surges [Part. 1].
- Welding power source ON/OFF switch [Part. 2].
- Power cable [Part. 3].
  - Total length (including internal part): 3.0 m
  - Number and cross section of wires: 3 x 2.5 mm<sup>2</sup>
  - Power plug type: Schuko

## 2.4 PREPARING FOR MMA WELDING

1. Set the welding power source ON/OFF switch to "O" (unit de-energized).
2. Plug the power cable plug into a mains socket outlet.
3. Choose the electrode based on the type of material and thickness of the workpiece to be welded.
4. Insert the electrode in the electrode holder.
5. Connect the electrode holder cable to the welding socket based on the polarity requested by the type of electrode used.
6. Connect the plug of the ground clamp to the welding socket on the basis of the polarity required.
7. Connect the earth clamp to the workpiece being processed.



**DANGER!**  
**Electric shock hazard!**

Read the warnings highlighted by the following symbols in the "General prescriptions for use".



8. Set the welding power source ON/OFF switch to "I" (unit powered).
9. Select the following welding mode on the user interface: MMA  
The system is ready to start welding.
10. Set the required welding parameter values on the user interface.  
The system is ready to start welding.

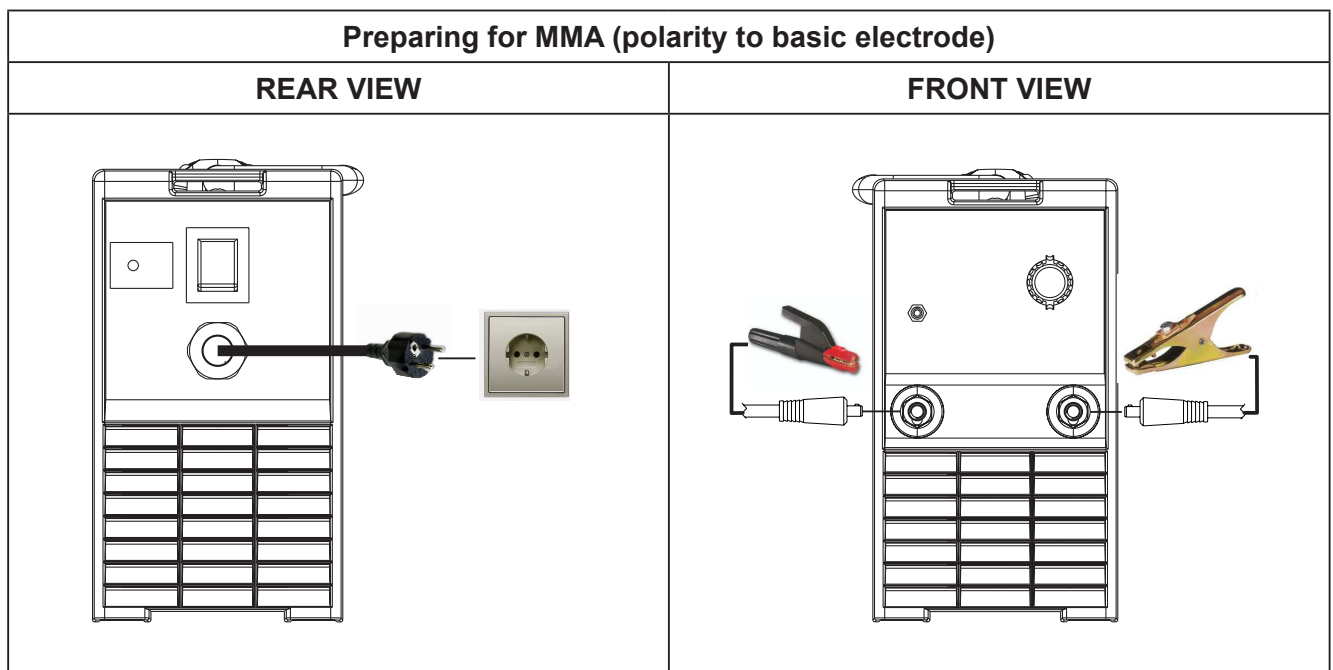



**ENGLISH**

**2.5 PREPARING FOR TIG WELDING**

1. Set the welding power source ON/OFF switch to “O” (unit de-energized).
2. Plug the power cable plug into a mains socket outlet.
3. Choose the electrode based on the type of material and thickness of the workpiece to be welded.
4. Insert the electrode in the TIG torch.
5. Connect the torch plug to the welding socket on the basis of the polarity required by the type of electrode in question.
6. Connect the plug of the ground clamp to the welding socket on the basis of the polarity required.
7. Connect the earth clamp to the workpiece being processed.
8. Set the welding power source ON/OFF switch to “I” (unit powered).
9. Select the following welding mode on the user interface: DC TIG
- ① This model of welding machine has not been provided either with the control for gas flow (solenoid valve) or with the torch button.

The system is ready to start welding.

**LIFT-ARC WELDING**

1. Open the torch valve to let the gas out.
2. Touch the workpiece with the torch electrode.
3. Slowly lift the torch to strike the arc.
- ➡ The WELDING CURRENT reaches the preset value.
4. Quickly move the torch clear of the workpiece to extinguish the welding arc.
5. Close the torch valve to interrupt the gas flow.

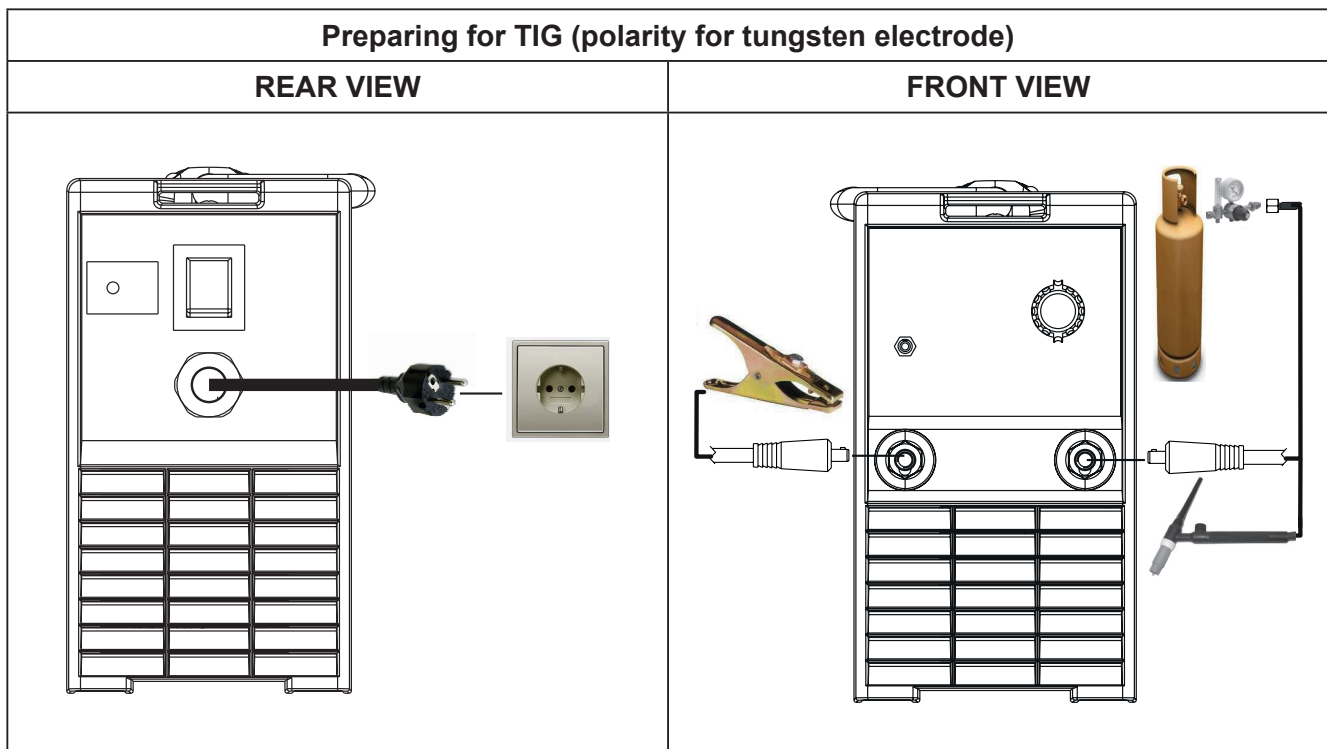





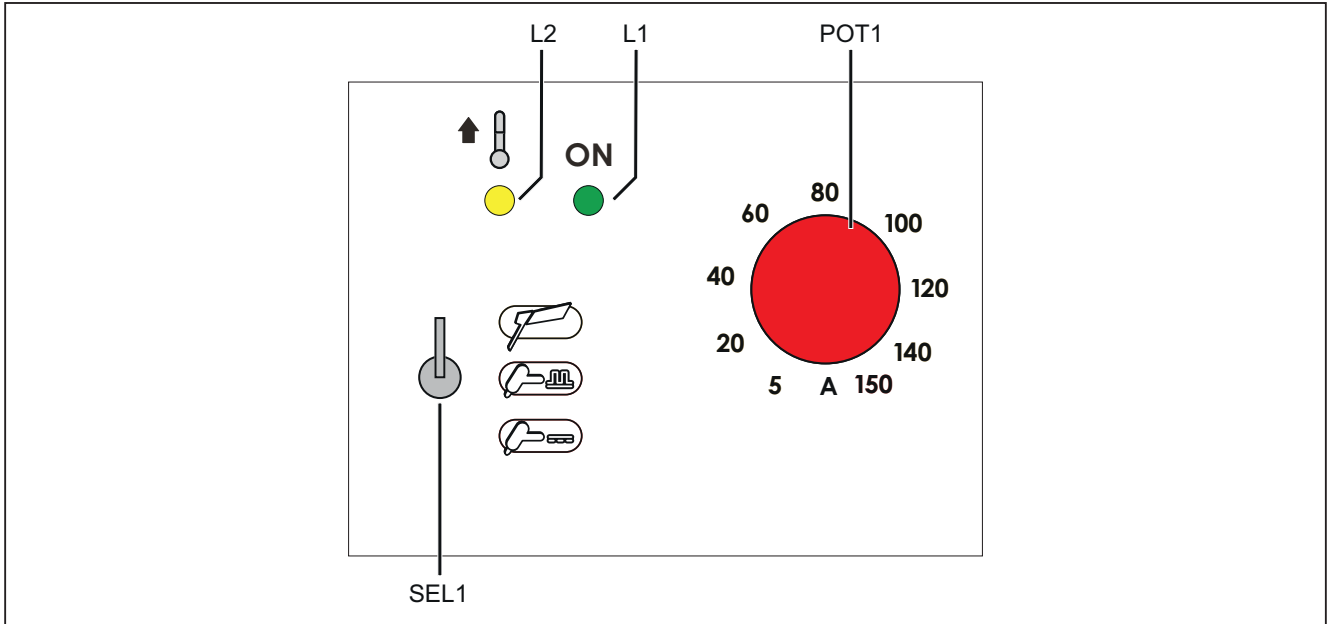

### 3 COMMISSIONING

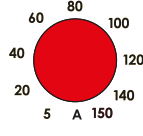
#### 3.1 USER INTERFACE



CODE	SYMBOL	DESCRIPTION
L1	<b>ON</b>	This LED illuminates to confirm the presence of power on the output sockets.
L2		<b>Overheating alarm</b> Indicates tripping of the welding power source thermal protection. Leave the unit running so that the overheated components cool as rapidly as possible. When the unit has cooled, the welding power source will reset automatically. <ul style="list-style-type: none"> <li>• Make sure that the power required by the welding process is lower than the maximum rated power output.</li> <li>• Check that the operating conditions are in compliance with the welding power source data plate specifications.</li> <li>• Check for the presence of adequate air circulation around the welding power source.</li> </ul>
POT1		The potentiometer sets the value of the following parameter: WELDING CURRENT
SEL1		MMA
		PULSED DC TIG
		TIG DC CONTINUOUS







**ENGLISH**

---

**3.2 WELDING PARAMETERS**

PARAMETER	MIN.	DEFAULT	MAX.	NOTES
WELDING CURRENT (MMA)	5 A	-	140 A	
WELDING CURRENT (TIG)	5 A	-	150 A	
PULSED CURRENT FREQUENCY	100 hZ			TIG only, set by the manufacturer.
HOT-START	50 %			Set by the manufacturer.
ARC FORCE	50 %			Set by the manufacturer.

## 4 TECHNICAL DATA

<b>Directives applied</b>	Waste electrical and electronic equipment (WEEE)		
	Electromagnetic compatibility (EMC)		
	Low voltage (LVD)		
	Restriction of the use of certain hazardous substances (RoHS)		
<b>Construction standards</b>	EN 60974-1; EN 60974-10 Class A		
<b>Conformity markings</b>	 Equipment compliant with European directives in force		
	 Equipment suitable in an environment with increased hazard of electric shock		
	 Equipment compliant with directive WEEE		
	 Equipment compliant with directive RoHS		
<b>Supply voltage</b>	1 x 230 Va.c. $\pm$ 15 % / 50-60 Hz		
<b>Mains protection</b>	16 A Delayed		
<b>Z<sub>max</sub></b>	This equipment complies with IEC 61000-3-12 provided that the maximum permissible system impedance is less than or equal to 27 m $\Omega$ at the interface point between the user's supply and the public system. It is the responsibility of the installer or user of the equipment to ensure, by consultation with the distribution network operator if necessary, that the equipment is connected only to a supply with maximum permissible system impedance less than or equal to 27 m $\Omega$ .		
<b>Dimensions ( L x D x H )</b>	310 x 120 x 215 mm		
<b>Weight</b>	4.4 kg		
<b>Insulation class</b>	B		
<b>Protection rating</b>	IP23S		
<b>Cooling</b>	AF: Air-over cooling (fan assisted)		
<b>Static characteristic</b>	MMA  Drooping characteristic		
	TIG  Drooping characteristic		
<b>Current and voltage adjustment range</b>		MMA	TIG
		10 A / 20.4 V - 140 A / 25.6 V	10 A / 10.4 V - 150 A / 16.0 V
<b>Welding current / Working voltage</b>	35% (40° C)	140 A / 25.6 V	150 A / 16.0 V
	60% (40° C)	110 A / 24.4 V	115 A / 14.6 V
	100% (40° C)	100 A / 24.0 V	100 A / 14.0 V
<b>Maximum input power</b>	35% (40° C)	5.6 kVA	4.1 kVA
	60% (40° C)	4.5 kVA	3.1 kVA
	100 % (40° C)	3.9 kVA	2.5 kVA
<b>Maximum supply current</b>	35% (40° C)	24.3 A	17.8 A
	60% (40° C)	19.2 A	13.2 A
	100 % (40° C)	17.0 A	10.9 A
<b>Maximum effective supply current</b>	35% (40° C)	14.3 A	10.5 A
	60% (40° C)	14.9 A	10.2 A
	100 % (40° C)	17.0 A	10.9 A
<b>No-load voltage (U<sub>0</sub>)</b>		94 V	
<b>Reduced no-load voltage (U<sub>r</sub>)</b>		-	11 V

**ENGLISH**

---

<b>Power source efficiency</b>	Efficiency (140A / 25,6V): 85,5%
	No-Load condition power consumption (U1= 230 Va.c.): 13,3 W
<b>Essential raw materials</b>	According to the information provided by our suppliers, this product does not contain essential raw materials in quantities greater than 1g per component.

## 5 SPARE PARTS

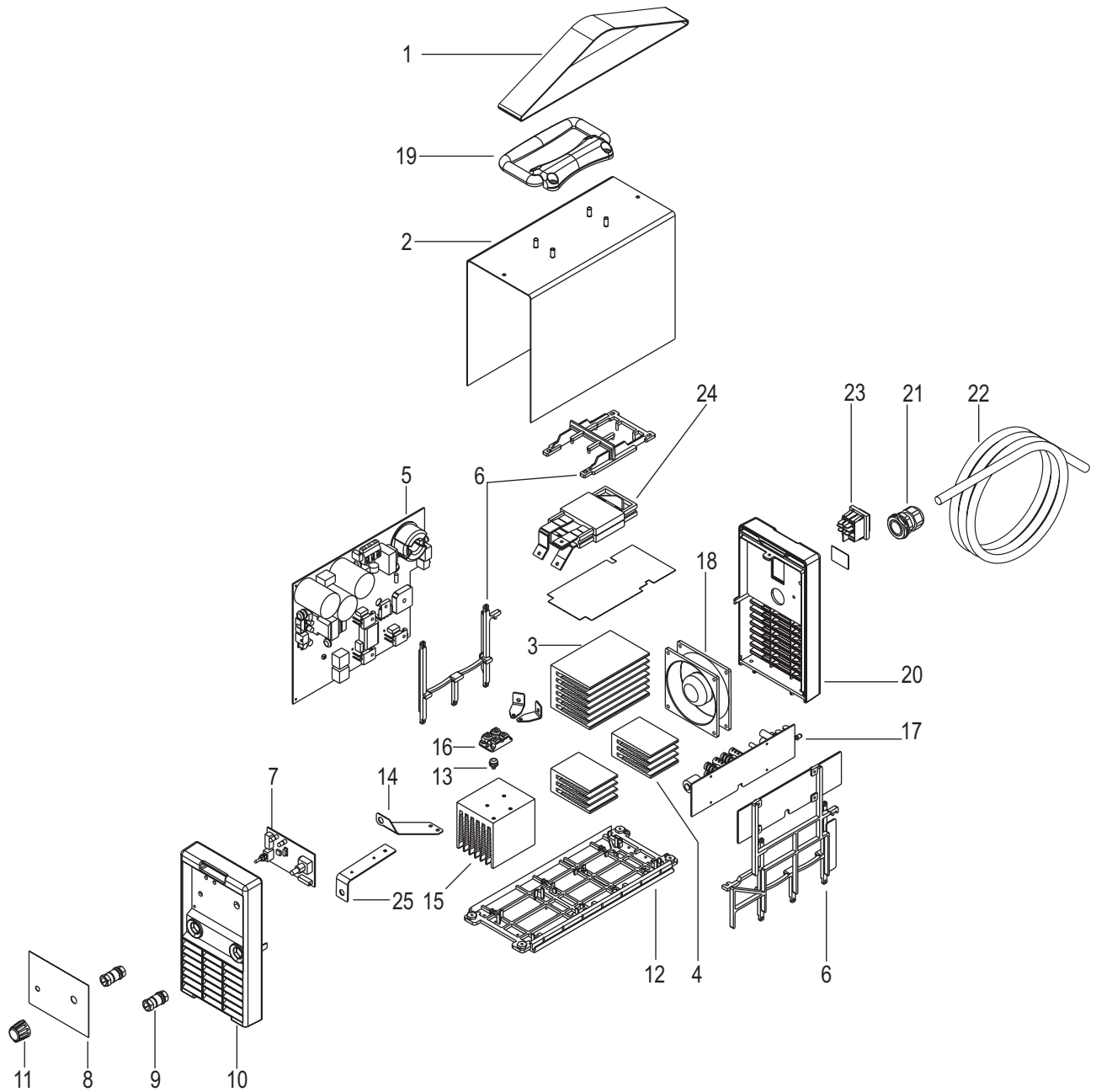

**ENGLISH**

N°	CODE	DESCRIPTION
1	005.0001.0002	BELT
2	011.0000.0021	COVER PLATE
3	015.0001.0001	HEAT SINK L= 107mm
4	015.0001.0002	HEAT SINK L= 50 mm
5	050.0006.0001	POWER BOARD
6	012.0001.0000	INTERNAL FRAMEWORKS
7	050.0001.0018	LOGIC BOARD
8	013.0015.0201	FRONT LABEL
9	021.0001.1022	FIXED SOCKET
10	012.0001.0150	FRONT PLASTIC PANEL
11	014.0002.0000	KNOB WITH CUP AND INDICATOR
12	012.0001.0007	LOWER COVER
13	040.0003.1080	TERMAL SWITCH 80° C
14	045.0006.0002	COPPER BRACKET
15	015.0001.0027	HEAT SINK L= 75 mm
16	032.0002.2403	ISOTOP DIODE
17	050.0001.0043	OVERCUT BOARD
18	003.0002.0001	FAN (150TP)
	003.0002.0002	FAN (150TP PLUS)
19	011.0006.0031	HANDLE
20	010.0006.0004	REAR PLASTIC PANEL
21	045.0000.0007	CABLE CLAMP
22	045.0002.0001	NEOPRENE CABLE
23	040.0001.0004	BI-POLE SWITCH
24	010.0007.0005	PLANAR TRANSFORMER
25	045.0005.0003	SHUNT

## 6 ELECTRICAL DIAGRAM

### 6.1 DISCOVERY 150TP

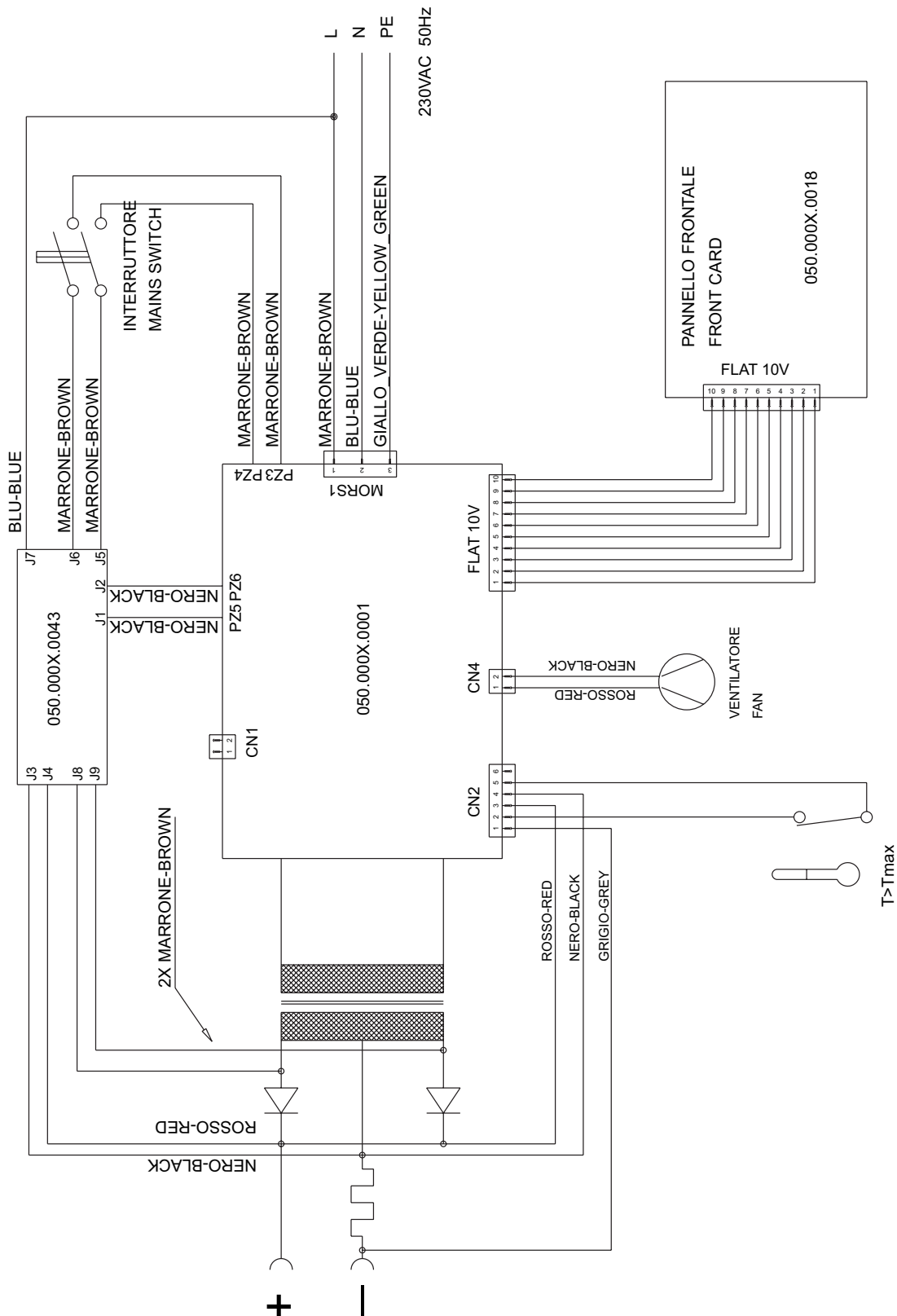





**WELD THE WORLD**

[www.weco.it](http://www.weco.it)

